

3656/3756 M & L-Group



CAST IRON, BRONZE FITTED, END-SUCTION FLANGED PUMPS

BOMBAS HORIZONTALES CON BRIDA EN HIERRO FUNDIDO O HIERRO FUNDIDO Y BRONCE

A FULL RANGE OF PRODUCT FEATURES

The 3656 and 3756 M & L-Group pumps from Goolds Water Technology have been designed with technical benefits to meet the needs of users in a variety of water supply, recirculation, and cooling applications.

- The model 3656 offers close coupled design for space saving and simplified maintenance.
- The model 3756 offers a bearing frame mounted design for flexibility of installation and drive arrangements.
- SAE drive sizes 1 through 5 available on all M and L sizes.
- Back pull-out to reduce maintenance down time.
- Standard Type 21 mechanical seal for both reliability and availability. Carbon/ceramic/BUNA standard, with other faces and elastomers available.
- Available in packed stuffing box design with Teflon™ impregnated packing, split Teflon lantern ring, tapped flush connection and 2 piece investment cast interlocking gland, all standard.
- Available in all iron or bronze fitted construction for application versatility.
- Replaceable wearing components include stainless steel shaft sleeve and casing and hub wear rings to maintain peak efficiency.

- Enclosed impeller design, dynamic balancing and renewable wear rings reduce losses affecting performance and pump life.
- 125 Class ANSI flange suction/discharge connections and casing rotation for piping connection versatility.
- NPT threaded connections are supplied on 1½ x 2 - 10 and 2½ x 3 - 8 models.
- Optional rigid carbon steel bedplate, sheet metal coupling guard and T. B. Woods spacer coupling for 3756 models.
- Standard NEMA motor frame, JM shaft extension (mechanical seal) JP shaft extension (packed box), C face mounting, single phase or three phase, 3500 or 1750 RPM for 60 Hz, 2900 or 1450 RPM for 50 Hz. Open drip-proof and totally enclosed fan cooled.*
- Optional explosion proof and high efficiency motors are available.*
- Optional casing rotation available - 3" (suction) and smaller can be rotated every 90°, 4" and larger can be rotated every 45°.
-  **NSF 61 Certification:** Pumps assembled at the factory are certified to the NSF/ANSI 61 Drinking Water System Components Standard. (Minimum usage of 2L/day for BF models. Buna seal models are not certified.)

* Premium efficiency where required by Department of Energy regulations.

UNA AMPLIA GAMA DE VARIADAS CARACTERÍSTICAS

Las bombas 3656 y 3756 del Grupo M y L de Goolds Water Technology han sido diseñadas con beneficios técnicos para satisfacer las necesidades de los usuarios en variadas aplicaciones de suministro y recirculación de agua y aplicaciones de refrigeración.

- El modelo 3656 cuenta con diseño de acoplamiento corto para ahorrar espacio y simplificar el mantenimiento.
- El modelo 3756 cuenta con diseño de montaje sobre bastidor que ofrece gran flexibilidad en los arreglos de instalación y accionamiento.
- El mecanismo impulsor del SAE clasifica 1 a 5 disponibles en todo el M y L tallas.
- Desmontaje posterior que reduce el tiempo de inactividad por mantenimiento.
- Sello mecánico estándar Tipo 21 brinda gran confiabilidad y asegura la disponibilidad. Estándar de carbono /cerámica / BUNA, también se encuentran disponibles con otras caras y elastómeros.
- Disponibles en diseño con caja prensaestopas con empaque de Teflon™ impregnado, aro de linterna de Teflon dividido, conexión de lavado con derivación y glándula fundida de conexión de inversión de 2 piezas, todo estándar.
- Fabricadas en todo hierro o con accesorios de bronce para una mayor versatilidad de aplicación.
- Los componentes de desgaste reemplazables incluyen los anillos de desgaste de la carcasa y del rodete y la camisa del eje, de acero inoxidable, para mantener la eficiencia pico.

- El diseño de impulsor encerrado, balanceo dinámico y anillos de desgaste reemplazables reducen las pérdidas que afectan el desempeño y la vida de la bomba.
 - Conexiones de succión y descarga con brida ANSI de 125 Clase y carcasa rotativa para mayor versatilidad de conexión.
 - Los modelos 1½ x 2 - 10 y 2½ x 3 - 8 cuentan con conexiones NPT.
 - Placa de asiento rígida de acero al carbono, protector de acoplamiento de chapa metálica y acoplamiento espaciador T. B. Woods disponibles como opción en los modelos 3756.
 - Bastidor de motor NEMA estándar, extensión de eje JM (sello mecánico), extensión JP (caja prensaestopas), montaje en cara C, monofásico o trifásico, 3500 ó 1750 RPM para 60 Hz, 2900 ó 1450 para 50 Hz. Abierto a prueba de filtraciones o totalmente encerrado enfriado por ventilador.*
 - Motores a prueba de explosiones y de alta eficiencia disponibles como opción.*
 - Rotación opcional de la cubierta disponible - 3" (succión) y más pequeño se pueden girar cada 90°, 4" y más grande se puede girar cada 45°.
 - **Certificación del NSF 61:** Las bombas ensambladas en la fábrica se certifican a los componentes de consumo del circuito de agua de NSF/ANSI 61 estándar. (El uso mínimo de 2L/day para el FB modela. Los modelos del sello del Buna no se certifican.)
- * Eficacia superior donde se requiera por el Ministerio de regulaciones de la Energía.

PERFORMANCE COVERAGE, CAMPO DE DESEMPEÑO

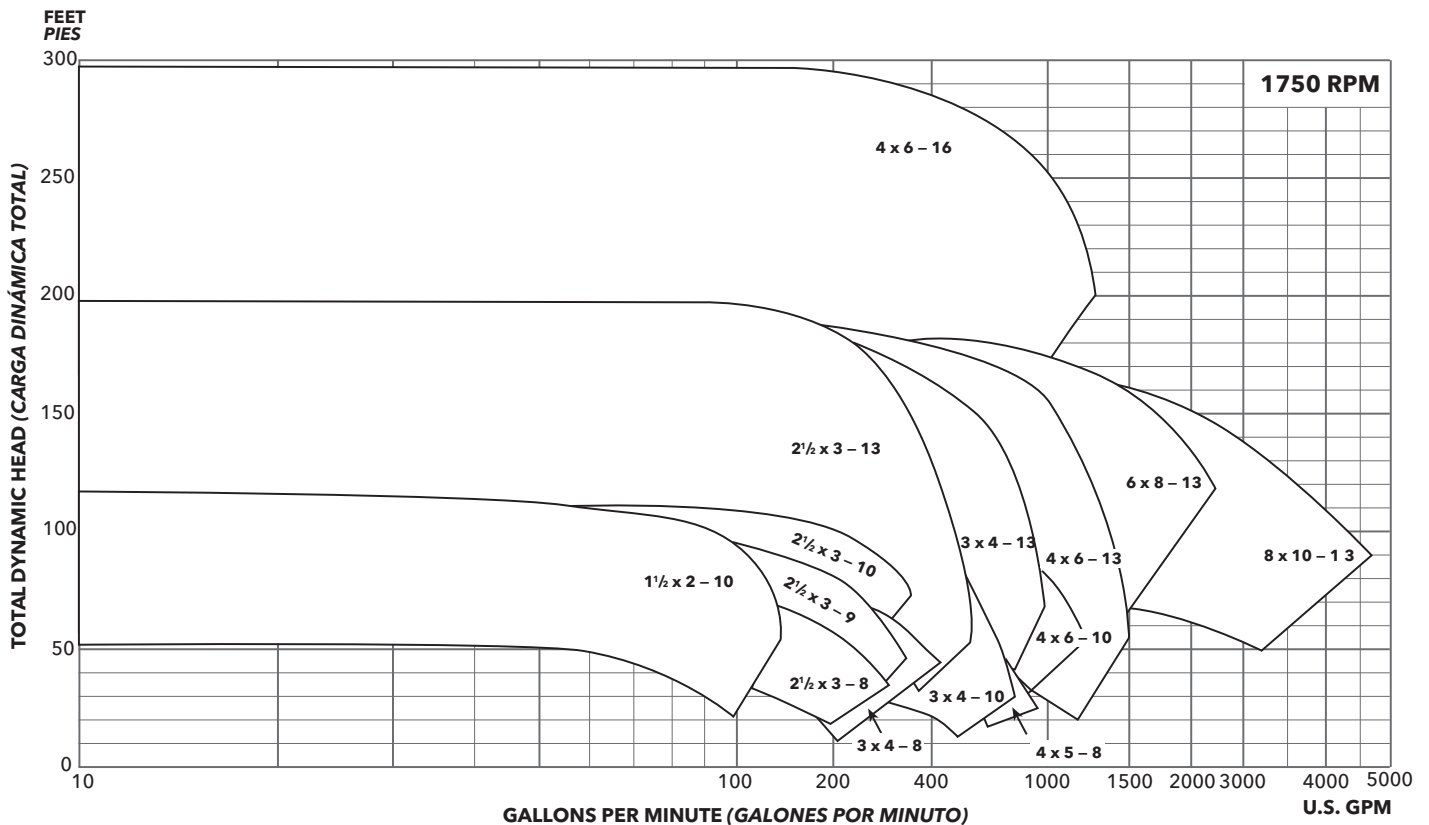
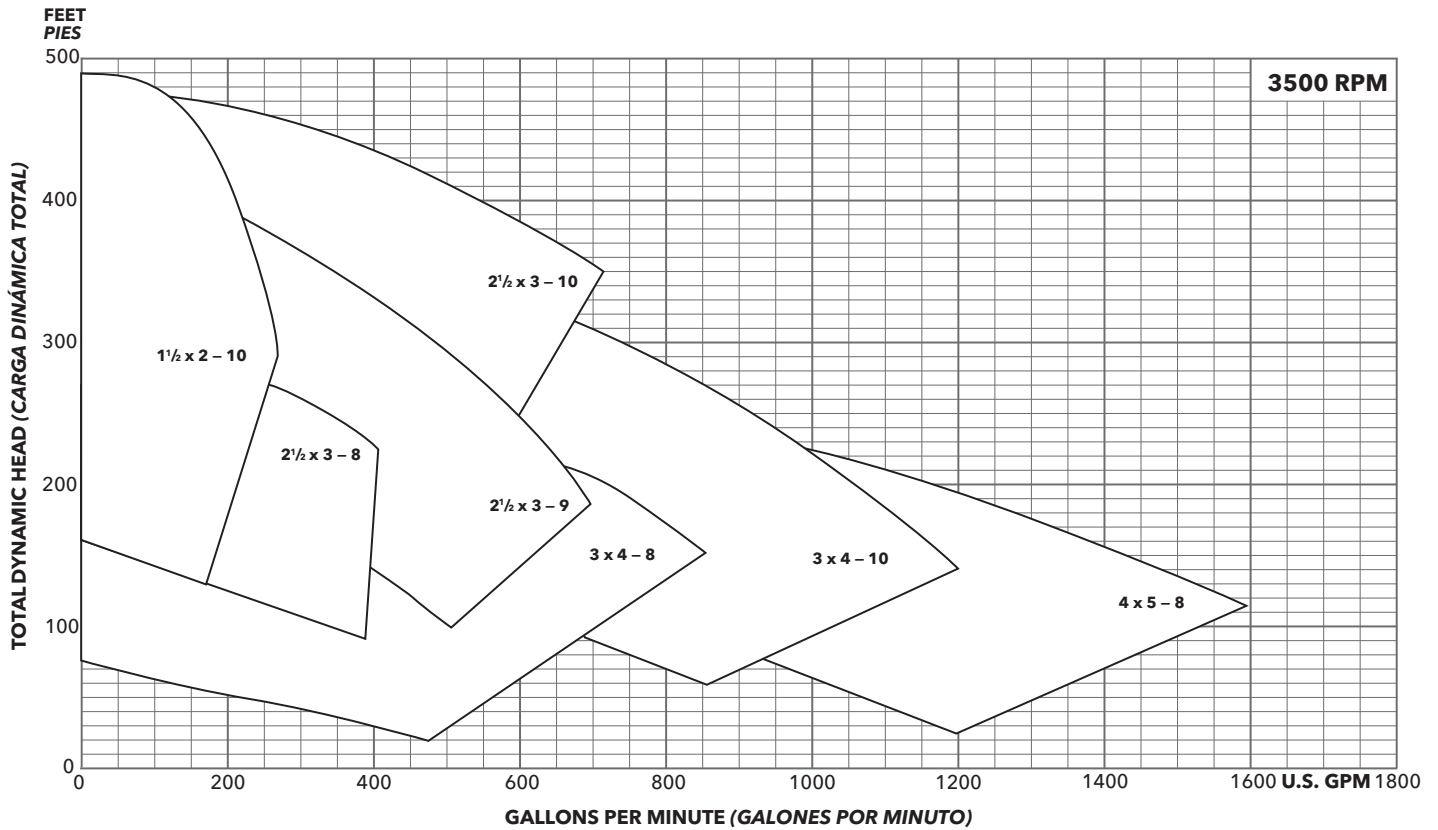

3656/3756 M-GROUP NUMBERING SYSTEM SISTEMA DE NUMERACIÓN DEL GRUPO M, MODELOS 3656/3756

The various versions of the 3656 and 3756 M-Group are identified by a product code number on the pump label. This number is also the catalog number for the pump. The meaning of each digit in the product code number is shown below. Not all combinations are possible; consult your Goulds Water Technology distributor for specific requirements.

Las diferentes versiones de los modelos 3656 y 3756 del Grupo M se identifican con un número de código de producto en la etiqueta de la bomba. Este número es también el número de catálogo de la bomba. A continuación se ilustra el significado de cada dígito en el código del producto. No todas las combinaciones son posibles, consulte a su distribuidor Goulds Water Technology para requisitos específicos.

Example Product Code, Ejemplo del código de producto

11 BF 2 L 5 A 0 R

Casing Rotation, Opcional

R = 3 o'clock B = 6 o'clock L = 9 o'clock

NOTE: Rotation when viewed from suction end of pump. Standard discharge position is 12 o'clock.

Rotación de la cubierta, opcional

R = 3 hora B = 6 hora L = 9 hora

NOTA: Rotación cuando está visto del extremo de la succión de la bomba. La posición estándar de la descarga es las 12.

Mechanical Seal/Packed Box and O-ring Material,

For Optional Mechanical Seal modify catalog order no. with Seal code listed below.

Materiales del sello mecánico/empaque y anillo en O

Para sellos mecánicos optativos, modificar el número de pedido del catálogo con los códigos de sello que se indican a continuación.

Seal Code, Código del Sello	Rotary, Rotativo	Stationary, Estacionario	Elastomers, Elastómeros	Metal Parts, Partes Metálicas	Part No., Pieza Número	
					M-Group, Grupo-M	
					180JM-210JM, 180JP-210TCZ*	250JM-360TCZ, 210JP-360TCZ*
0	Carbon, Carbone	Ceramic, Cerámica	BUNA-N	316 SS, 316 Acero inoxidable	10K13	10K16
1			EPR		10K19	10K20
3		Viton	Sil-Carbide, Carburo de silicona		10K27	10K45
5	10K64				10K65	
8B*	10K64			10K65		
9**	Packed Box Design with BUNA O-Ring, Diseño de prensaestopas empacado con anillo en O de BUNA			15K17	15K3	

* Prime-Safe option with grease, Opción Primero-Segura con la grasa.

** All Packed Box Units use JP style motors, Todas las unidades de prensaestopas empacado utilizan motores estilo JP.

Impeller Option Code

* Indicates 3500 RPM impeller for the 3 x 4 - 10, all others are 1750 RPM.

NOTE: For trimmed impellers, use T for impeller code.

Código de opción de impulsor

* Indica un impulsor de 3500 RPM para el 3 x 4 - 10, todos los demás son de 1750 RPM.

NOTA: Para los impulsores cortados, utilice T para el código del impulsor.

Impeller Code, Código del impulsor	M-Group Pump Size, Tamaño de la bomba										
	8	7	11	13	16	12	14	10	17	15	21
	Dia.	Dia.	Dia.	Dia.	Dia.	Dia.	Dia.	Dia.	Dia.	Dia.	Dia.
A	10 1/16"	7 15/16"	10 1/16"	13 1/16"	8 1/16"	10 1/16"	13 1/16"	8 1/16"	10 1/16"	12 7/8"	10 1/16"
B	9 3/16"	7 7/16"	9 7/8"	12 3/4"	7 1/16"	9 3/4"	12 3/16"	7 3/4"	9 3/16"	12 1/2"	9 7/8"
C	8 3/8"	7 3/16"	9 5/8"	12 1/4"	7 1/16"	9	12 3/16"	7 1/2"	9 1/8"	12 1/4"	9 1/2"
D	7 3/4"	6 13/16"	9	11 3/4"	6 3/4"	8 5/8"	12	7 1/4"	8 1/16"	11 7/8"	9 1/4"
E	7 1/4"	6 3/8"	8 5/8"	11 1/4"	6 3/8"	8 1/8"	11 3/4"	6 3/4"	8 1/8"	11 3/8"	8 15/16"
F	7	6 3/16"	8 1/4"	10 3/4"	5 15/16"	7 7/8"	11 3/16"	6 1/2"	7 3/4"	11 1/16"	8 1/2"
G			8	10 1/4"	5 1/2"	*9 1/8"	10 3/4"	6 1/16"		10 7/8"	8 3/16"
H			7 5/8"	9 1/2"	5 1/8"	*8 3/4"	10 1/8"	5 3/4"		10 1/2"	8
J			7 1/8"		4 5/8"	*8 7/16"	9 1/8"			10 1/4"	7 11/16"
K						*8 1/8"	8 1/16"			9 7/8"	
L						*7 3/4"	8			9 3/8"	
M						*7 5/8"	7 1/16"			13 1/16"	
N						*7 1/4"					
P						*7 1/16"					
Q											
R						*6 3/4"					

NOTE: Impellers will be trimmed in 1/16" increments only. If you are ordering a trim within 1/16" of the standard impeller, you will receive the standard impeller trim.

NOTA: Los impulsores serán cortados en 1/16" incrementos solamente. Si usted está pidiendo un ajuste dentro de 1/16" del impulsor estándar, usted recibirá el ajuste estándar del impulsor.

Driver, Elemento motor

1 = 1 PH, ODP 4 = 1PH, TEFC 7 = 3 PH, XP 0 = 1 PH, XP C = 3 PH, WD PE F = 1 PH, ODP PE

2 = 3 PH, ODP 5 = 3 PH, TEFC 8 = 3 PH, 575 V, XP A = 3 PH, 575 TE PE D = 3 PH, 575 ODP PE G = 1 PH, TE PE

3 = 3 PH, 575 V, ODP 6 = 3 PH, 575 V, TEFC 9 = 3 PH, TE PE B = 3 PH, ODP PE E = 3 PH, XP PE

1PH = monofásico, 3PH = trifásico PE = Premium efficiency, Eficiencia superior

HP Rating, Potencia nominal, HP

G = 2 J = 5 L = 10 N = 20 Q = 30 S = 50 U = 75 W = 125

H = 3 K = 7 1/2 M = 15 P = 25 R = 40 T = 60 V = 100 X = 150

Driver: Hertz/Pole/RPM, Elemento motor: Hertz/Polos/RPM

1 = 60 Hz, 2 pole, 3500 RPM 3 = 60 Hz, 6 pole, 1180 RPM 5 = 50 Hz, 4 pole, 1450 RPM

2 = 60 Hz, 4 pole, 1750 RPM 4 = 50 Hz, 2 pole, 2900 RPM

Material (Packed Box in AI or BF), Material (Caja prensaestopas en AI o BF)

AI = All iron BF = Bronze fitted AI = Todo hierro BF = con accesorios de bronce

Pump Size, Tamaño de bomba

*7 = 2 1/2 x 3 - 8 11 = 2 1/2 x 3 - 10 14 = 3 x 4 - 13 17 = 4 x 6 - 10 (BF Only) (Accesorios de bronce únicamente)

8 = 1 1/2 x 2 - 10 12 = 3 x 4 - 10 15 = 4 x 6 - 13 21 = 2 1/2 x 3 - 9 (BF Only)

*10 = 4 x 5 - 8 13 = 2 1/2 x 3 - 13 *16 = 3 x 4 - 8

* When ordered as a bare shaft pump the motor speed must be specified as 2 pole or 4 pole. The 4 pole models will utilize S-Group bearing frame.

* Cuando se ordena como bomba de eje desnudo, la velocidad del motor debe especificarse como 2 polos o 4 polos. Los modelos de 4 polos utilizarán el bastidor de rodamiento del grupo S.

Drive Options, Opciones de mando

Substitute, Substituto	Description, Descripción
FRM	Bearing frame mount, Montaje del bastidor del cojinete
*FRM2	Bearing frame mount 2-pole operation, Montaje del bastidor del cojinete operación de 2 polos
*FRM4	Bearing frame mount 4-pole operation, Montaje del bastidor del cojinete operación de 4 polos
SAE1	SAE #1 mount, Montura SAE #1
SAE2	SAE #2 mount, Montura SAE #2
	SAE #3 mount, Montura SAE #3
SAE4	SAE #4 mount, Montura SAE #4
	SAE #5 mount, Montura SAE #5

SAE drive number is determined by the engine flywheel housing size.

El número del mando SAE se determina por el tamaño de la caja del volante del motor.

3656/3756 L-GROUP NUMBERING SYSTEM SISTEMA DE NUMERACIÓN DEL GRUPO L, MODELOS 3656/3756

The various versions of the 3656 and 3756 L-Group are identified by a product code number on the pump label. This number is also the catalog number for the pump. The meaning of each digit in the product code number is shown below. Not all combinations are possible; consult your Goolds Water Technology distributor for specific requirements.

Las diferentes versiones de los modelos 3656 y 3756 del Grupo L se identifican con un número de código de producto en la etiqueta de la bomba. Este número es también el número de catálogo de la bomba. A continuación se ilustra el significado de cada dígito en el código del producto. No todas las combinaciones son posibles, consulte a su distribuidor Goolds Water Technology para requisitos específicos.

Example Product Code, Ejemplo del código de producto

18 BF 2 Q 2 J 0 R

Casing Rotation, Optional

R = 3 o'clock B = 6 o'clock L = 9 o'clock

NOTE: Rotation when viewed from suction end of pump. Standard discharge position is 12 o'clock.

Rotación de la cubierta, opcional

R = 3 hora B = 6 hora L = 9 hora

NOTA: Rotación cuando está visto del extremo de la succión de la bomba. La posición estándar de la descarga es las 12.

Mechanical Seal/Packed Box and O-ring Material,

For Optional Mechanical Seal modify catalog order no. with Seal code listed below.

Materiales del sello mecánico/empaque y anillo en O

Para sellos mecánicos optativos, modificar el número de pedido del catálogo con los códigos de sello que se indican a continuación.

Seal Code, Código del Sello	Rotary, Rotativo	Stationary, Estacionario	Elastomers, Elastómeros	Metal Parts, Partes Metálicas	Part No., Pieza Número
					L-Group, Grupo-L
0	Carbon, Carbone	Ceramic, Cerámica	BUNA-N	316 SS, 316 Acero inoxidable	10K84
1					NA
3					10K112
5	Sil-Carbide	Sil-Carbide, Carburo de silicón	Viton		10K144
8A*					
8B**					
9***	Packed Box Design with BUNA O-Ring, Diseño de prensaestopas empaçado con anillo en O de BUNA				15K4

* Prime-Safe option with oiler, Opción Primero-Segura con el engrasador

** Prime-Safe option with grease, Opción Primero-Segura con la grasa

*** All Packed Box Units use JP style motors, Todas las unidades de prensaestopas empaçadas utilizan motores estilo JP

Impeller Option Code, Código de opción de impulsor

Impeller Code, Código del impulsor	L-Group Pump Size, Tamaño de la bomba		
	18 Dia.	19 Dia.	20 Dia.
A	n13"	n13"	n16"
B	n12 1/2"	n12 3/4"	n15 5/8"
C	n12 5/16"	n12 3/8"	n15 3/16"
D	n11 7/8"	n11 15/16"	n14 1/2"
E	11 5/8"	n11 11/16"	n13 3/4"
F	11 1/8"	n11 1/4"	
G	10 7/8"	n10 7/8"	
H	10 1/2"	n9 13/16"	
J	10	• 13	
K	9 1/2"	• 12 3/4"	
L	• 13	• 12 3/8"	
M	• 12 1/2"	• 11 15/16"	
N	• 12 5/16"	• 11 11/16"	
P	• 11 7/8"	• 11 1/4"	
Q		• 10 7/8"	
R		• 9 13/16"	

n Indicates L-Group pump (1780 RPM, 60 to 150 HP)

• For 1180 RPM Close-Coupled applications only.

NOTE: For trimmed impellers, use T for impeller code.

n Indica una bomba Grupo "L". (1780 RPM, de 60 a 150 HP)

• Para aplicaciones de acople cerrado de 1180 RPM únicamente.

NOTA: Para los impulsores cortados, utilice T para el código del impulsor.

NOTE: Impellers will be trimmed in 1/16" increments only. If you are ordering a trim within 1/16" of the standard impeller, you will receive the standard impeller trim.

NOTA: Los impulsores serán cortados en 1/16" incrementos solamente. Si usted está pidiendo un ajuste dentro de 1/16" del impulsor estándar, usted recibirá el ajuste estándar del impulsor.

Driver, Elemento motor

1 = 1 PH, ODP 4 = 1PH, TEFC 7 = 3 PH, XP 0 = 1 PH, XP C = 3 PH, WP PE F = 1 PH, ODP PE

2 = 3 PH, ODP 5 = 3 PH, TEFC 8 = 3 PH, 575 V, XP A = 3 PH, 575 TE PE D = 3 PH, 575 ODP PE

3 = 3 PH, 575 V, ODP 6 = 3 PH, 575 V, TEFC 9 = 3 PH, TE PE B = 3 PH, ODP PE E = 3 PH, XP PE

1PH = monofásico, 3PH = trifásico PE = Premium efficiency, Eficiencia superior

HP Rating, Potencia nominal, HP

G = 2 J = 5 L = 10 N = 20 Q = 30 S = 50 U = 75 W = 125

H = 3 K = 7 1/2 M = 15 P = 25 R = 40 T = 60 V = 100 X = 150

Driver: Hertz/Pole/RPM, Elemento motor: Hertz/Polos/RPM

1 = 60 Hz, 2 pole, 3500 RPM 3 = 60 Hz, 6 pole, 1180 RPM 5 = 50 Hz, 4 pole, 1450 RPM

2 = 60 Hz, 4 pole, 1750 RPM 4 = 50 Hz, 2 pole, 2900 RPM

Material (Packed Box in BF), Material (Caja prensaestopas en BF)

BF = Bronze fitted, BF = con accesorios de bronce

Pump Size, Tamaño de bomba

18BF = 6 x 8 - 13

19BF = 8 x 10 - 13

20BF = 4 x 6 - 16

(BF Only) (Accesorios de bronce únicamente)

Drive Options, Opciones de mando

Substitute, Substituto	Description, Descripción
FRM	Bearing frame mount, Montaje del bastidor del cojinete
SAE1	SAE #1 mount, Montura SAE #1
SAE2	SAE #2 mount, Montura SAE #2
	SAE #3 mount, Montura SAE #3
SAE4	SAE #4 mount, Montura SAE #4
	SAE #5 mount, Montura SAE #5

SAE drive number is determined by the engine flywheel housing size.

El número del mando SAE se determina por el tamaño de la caja del volante del motor.

Commercial Water

PERFORMANCE CURVES - 60 HZ, 3500 RPM CURVAS DE DESEMPEÑO - 60 HZ, 3500 RPM

These curves show the performance of the 3656 and 3756 at 3500 RPM and 1750 RPM, 60 Hz, and at 2900 RPM and 1450 RPM, 50 Hz. Standard impeller trims are shown. Note that not all pump sizes are available at the higher speeds.

Estas curvas ilustran el desempeño de los modelos 3656 y 3756 operando a 3500 RPM y 1750 RPM en 60 Hz, y a 2900 RPM y 1450 RPM en 50 Hz. Se muestran los diámetros de impulsor estándar. Se ha de notar que no todos los tamaños de bomba están disponibles en altas velocidades.

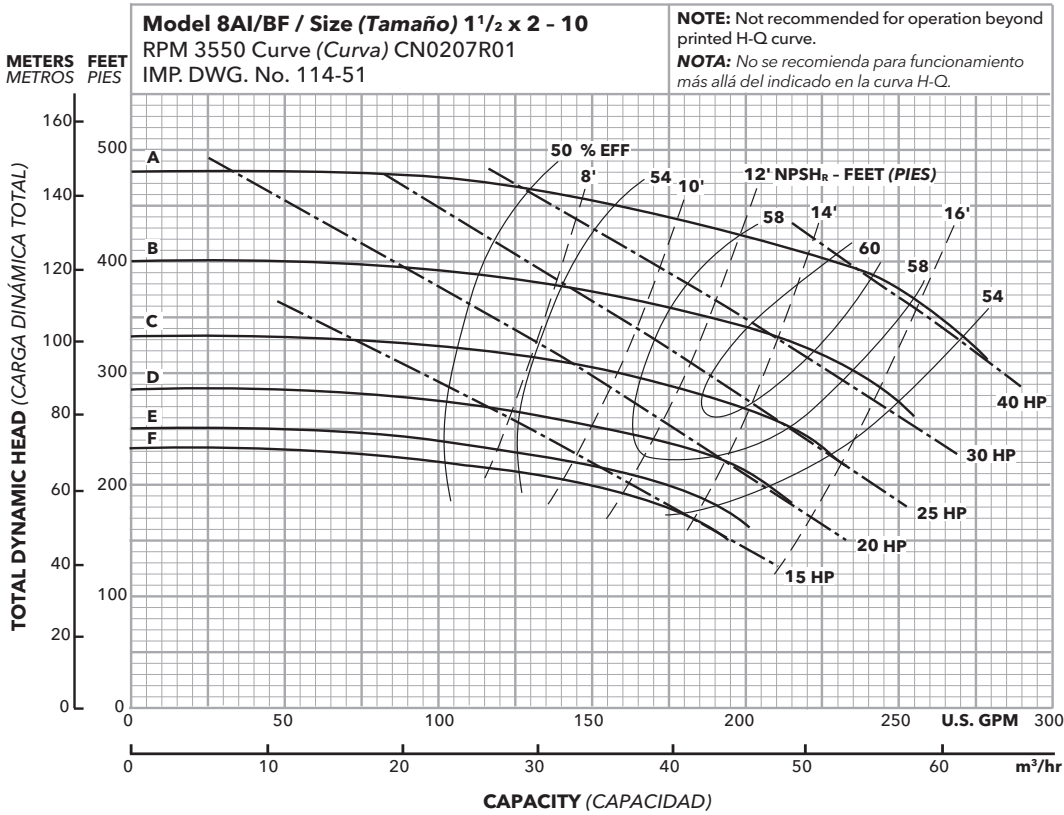

Optional Impeller Impulsor optativo	
Ordering Code Código de pedido	Dia. Diá.
A	10 1/16"
B	9 3/16"
C	8 3/8"
D	7 3/4"
E	7 1/4"
F	7"

NOTE: Pump will pass a sphere to 5/32" diameter.

NOTA: La bomba dejará pasar una esfera de hasta 5/32 de pulgada de diámetro.

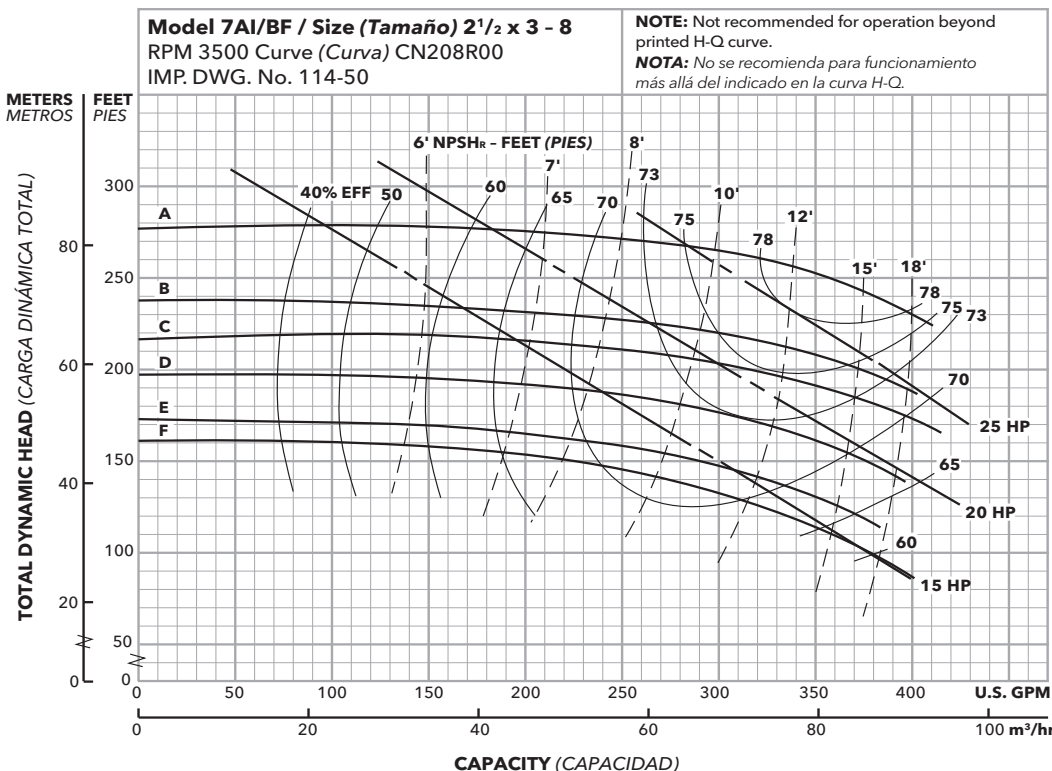

Optional Impeller Impulsor optativo	
Ordering Code Código de pedido	Dia. Diá.
A	7 15/16"
B	7 7/16"
C	7 3/16"
D	6 13/16"
E	6 3/8"
F	6 3/16"

NOTE: Pump will pass a sphere to 5/16" diameter.

NOTA: La bomba dejará pasar una esfera de hasta 5/16 de pulgada de diámetro.

Commercial Water

PERFORMANCE CURVES - 60 HZ, 3500 RPM CURVAS DE DESEMPEÑO - 60 HZ, 3500 RPM

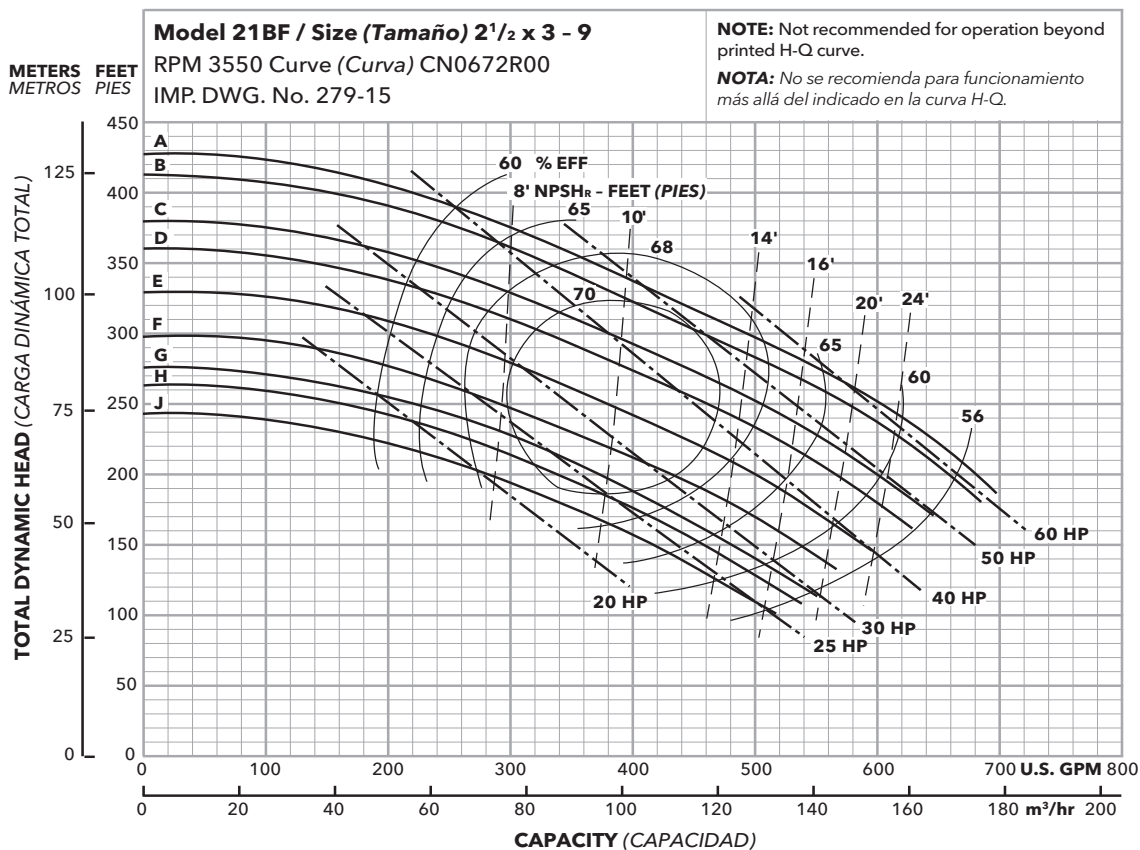

Optional Impeller Impulsor optativo	
Ordering Code Código de pedido	Dia. Diá.
A	10 ¹ / ₁₆ "
B	9 ⁷ / ₈
C	9 ¹ / ₂
D	9 ¹ / ₄
E	8 ¹⁵ / ₁₆
F	8 ¹ / ₂
G	8 ³ / ₁₆
H	8
J	7 ¹ / ₁₆

NOTE: Pump will pass a sphere to ⁵/₁₆" diameter.

NOTA: La bomba dejará pasar una esfera de hasta ⁵/₁₆ de pulgada de diámetro.

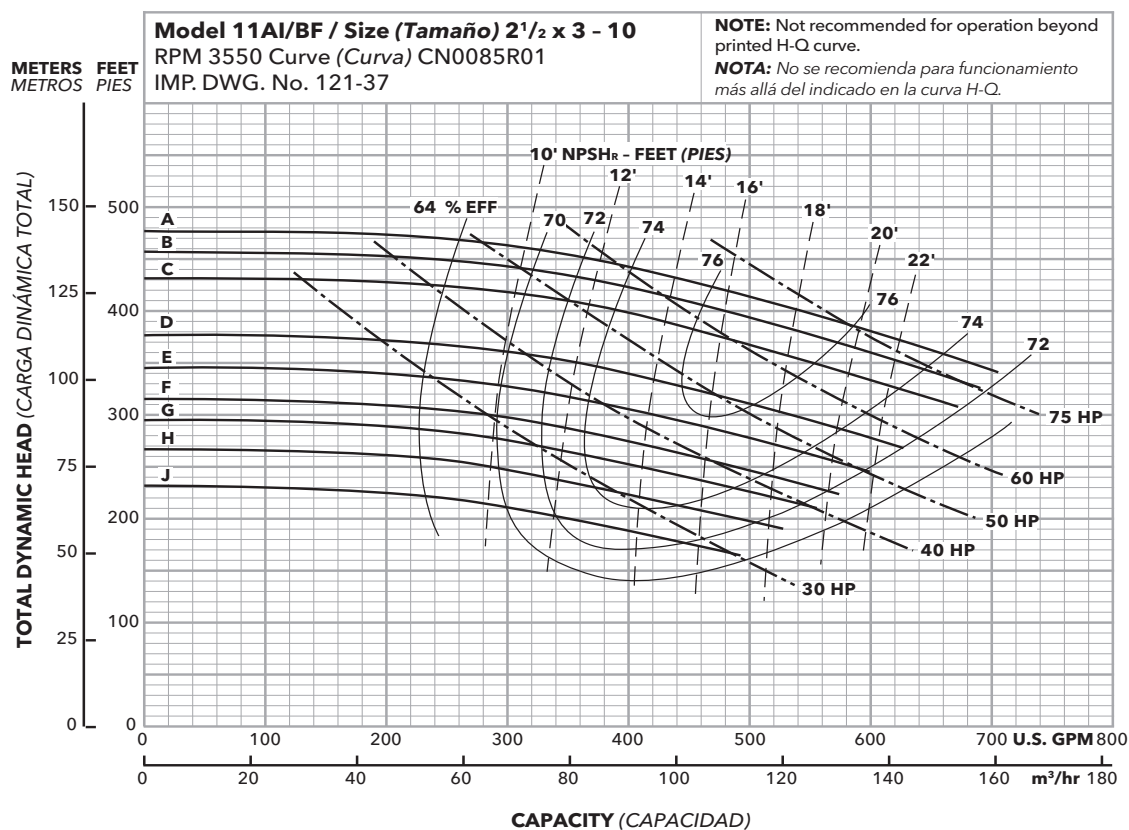

Optional Impeller Impulsor optativo	
Ordering Code Código de pedido	Dia. Diá.
A	10 ¹ / ₁₆ "
B	9 ⁷ / ₈
C	9 ⁵ / ₈
D	9
E	8 ⁵ / ₈
F	8 ¹ / ₄
G	8
H	7 ⁵ / ₈
J	7 ¹ / ₈

NOTE: Pump will pass a sphere to ⁵/₁₆" diameter.

NOTA: La bomba dejará pasar una esfera de hasta ⁵/₁₆ de pulgada de diámetro.

PERFORMANCE CURVES - 60 HZ, 3500 RPM CURVAS DE DESEMPEÑO - 60 HZ, 3500 RPM

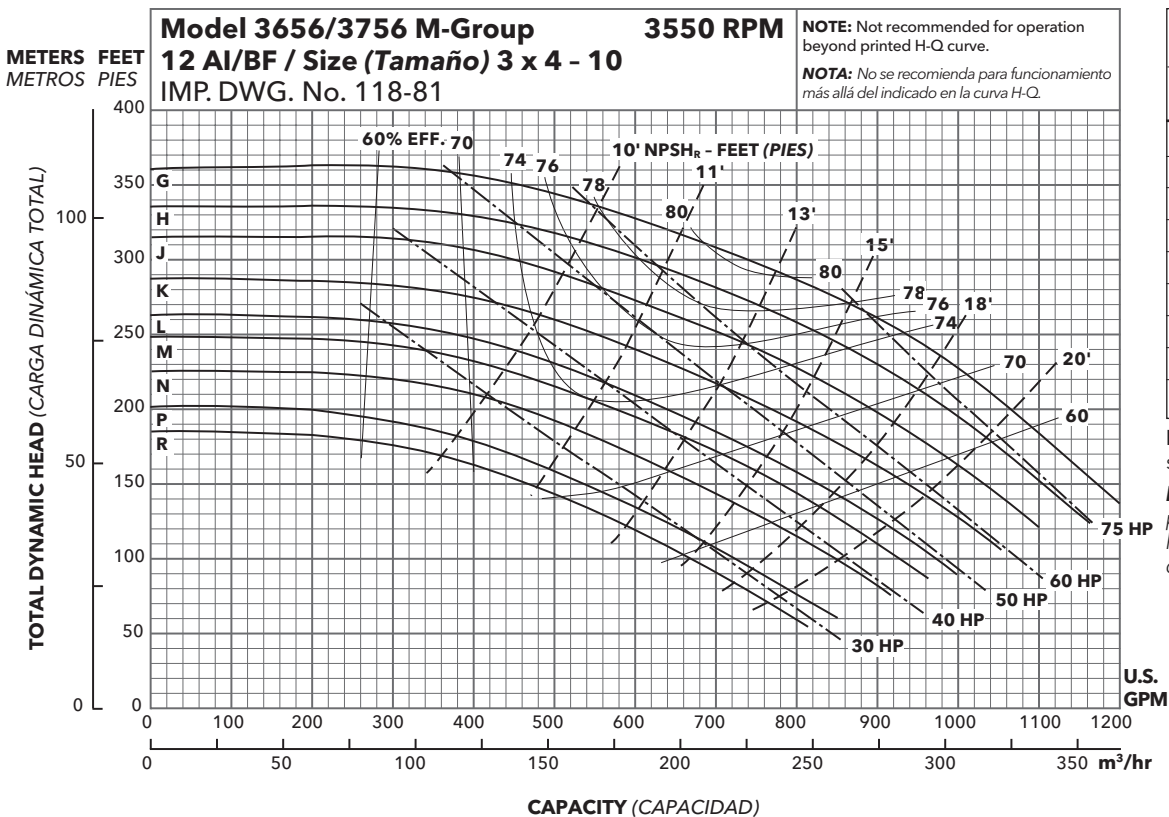
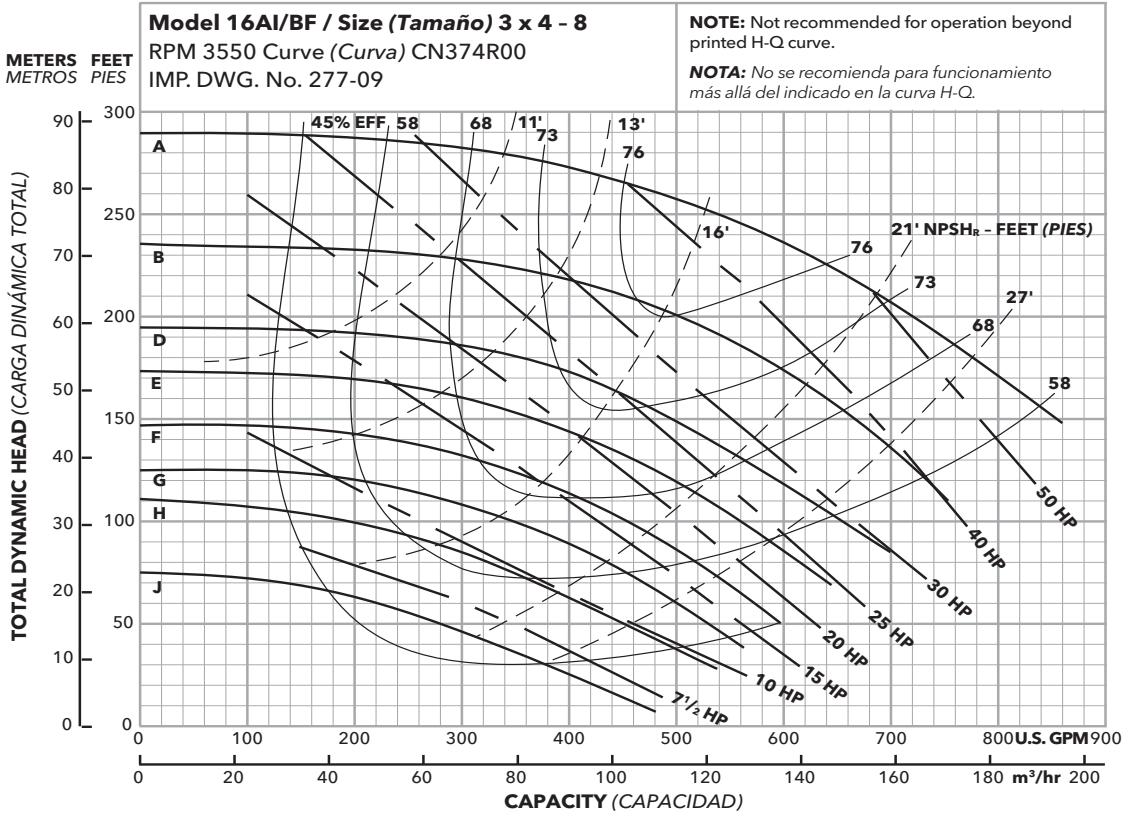

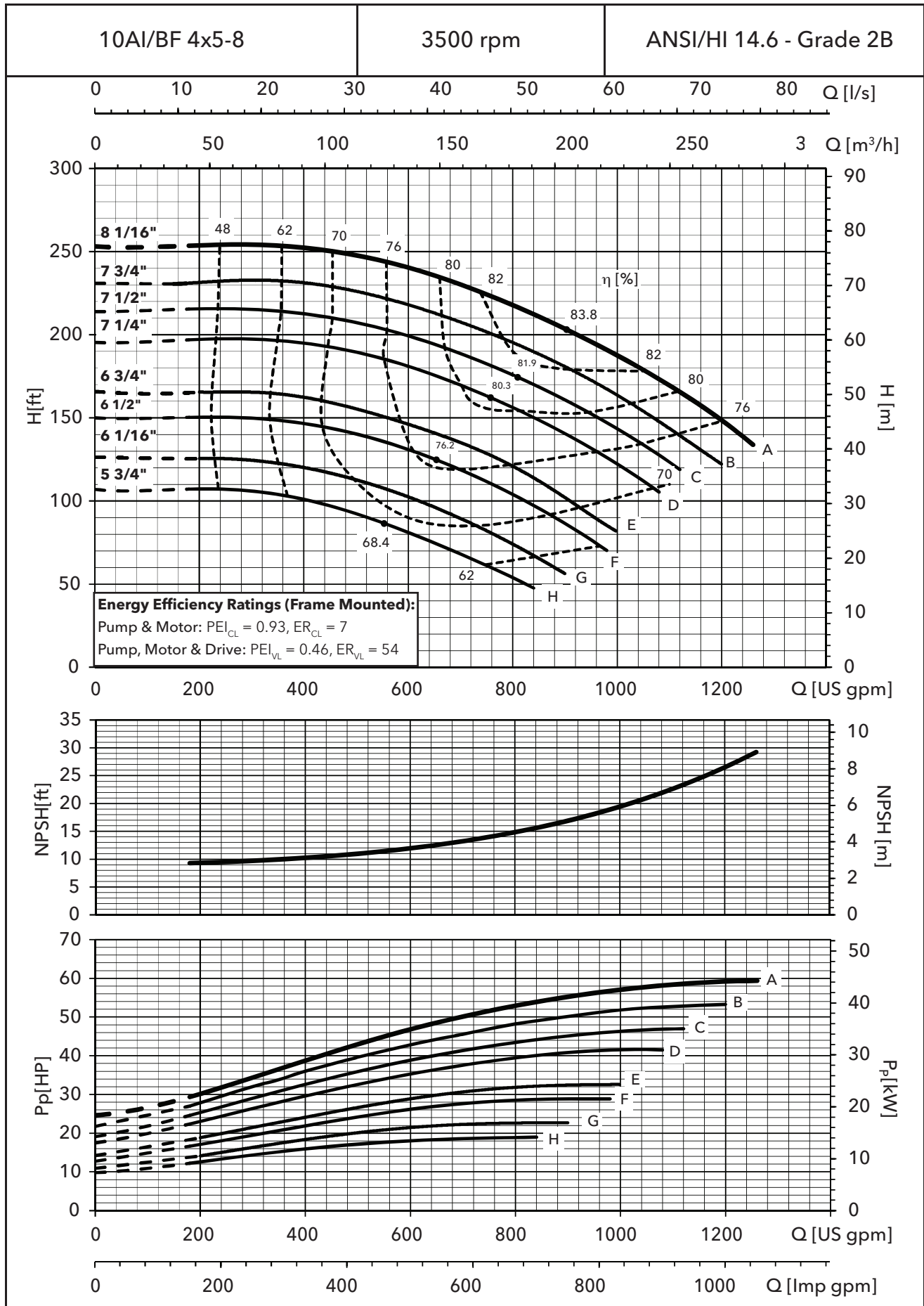

PERFORMANCE CURVES - 60 HZ, 1750 RPM CURVAS DE DESEMPEÑO - 60 HZ, 1750 RPM

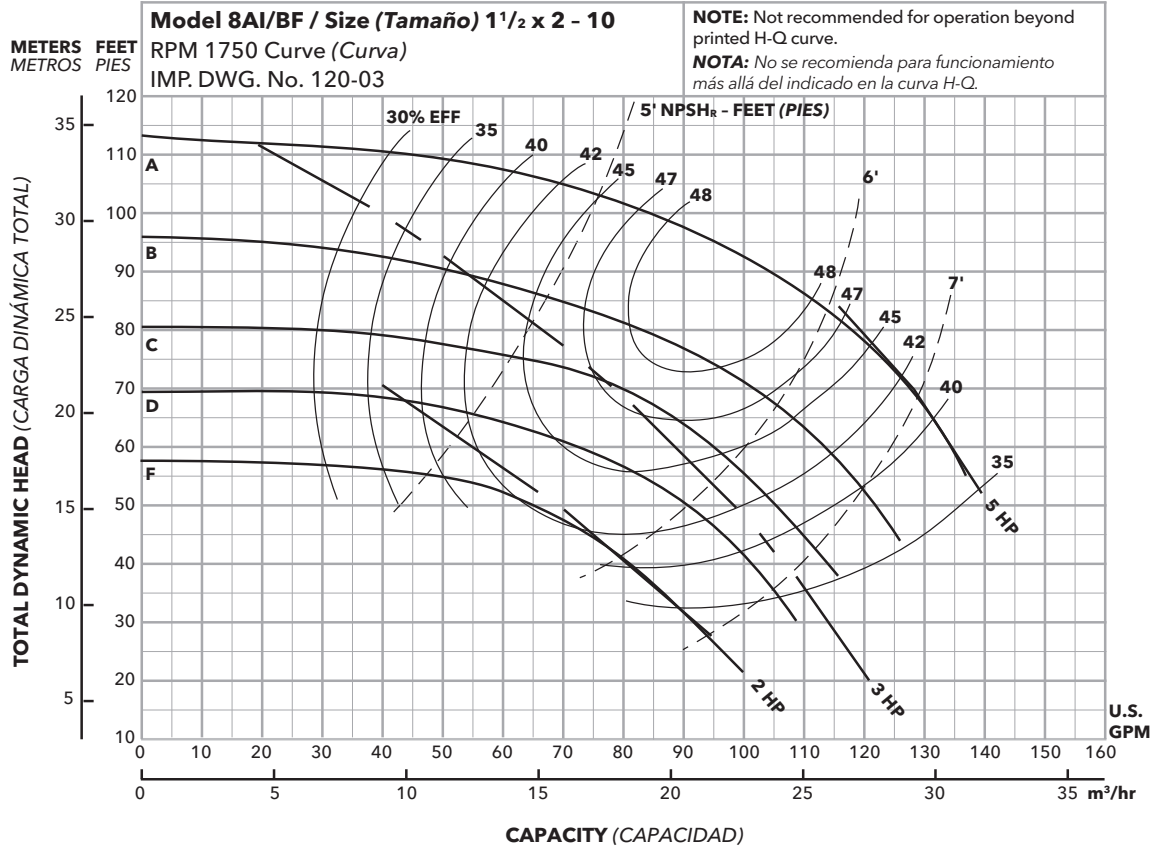

Optional Impeller Impulsor optativo	
Ordering Code Código de pedido	Dia. Diá.
A	10 1/16"
B	9 3/16"
C	8 3/8"
D	7 3/4"
F	7"

NOTE: Pump will pass a sphere to 5/32" diameter.

NOTA: La bomba dejará pasar una esfera de hasta 5/32 de pulgada de diámetro.

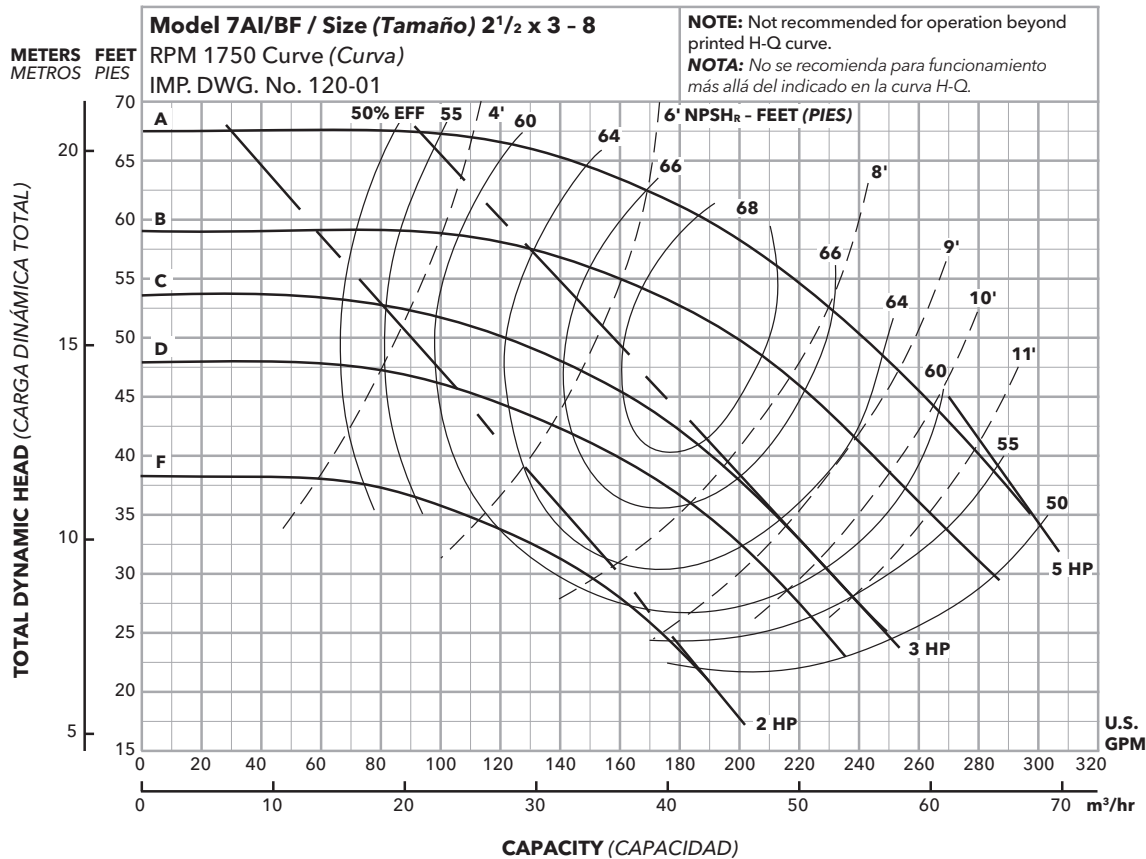

Optional Impeller Impulsor optativo	
Ordering Code Código de pedido	Dia. Diá.
A	7 15/16"
B	7 7/16"
C	7 3/16"
D	6 13/16"
F	6 3/16"

NOTE: Pump will pass a sphere to 5/16" diameter.

NOTA: La bomba dejará pasar una esfera de hasta 5/16 de pulgada de diámetro.

Commercial Water

PERFORMANCE CURVES - 60 HZ, 1750 RPM CURVAS DE DESEMPEÑO - 60 HZ, 1750 RPM

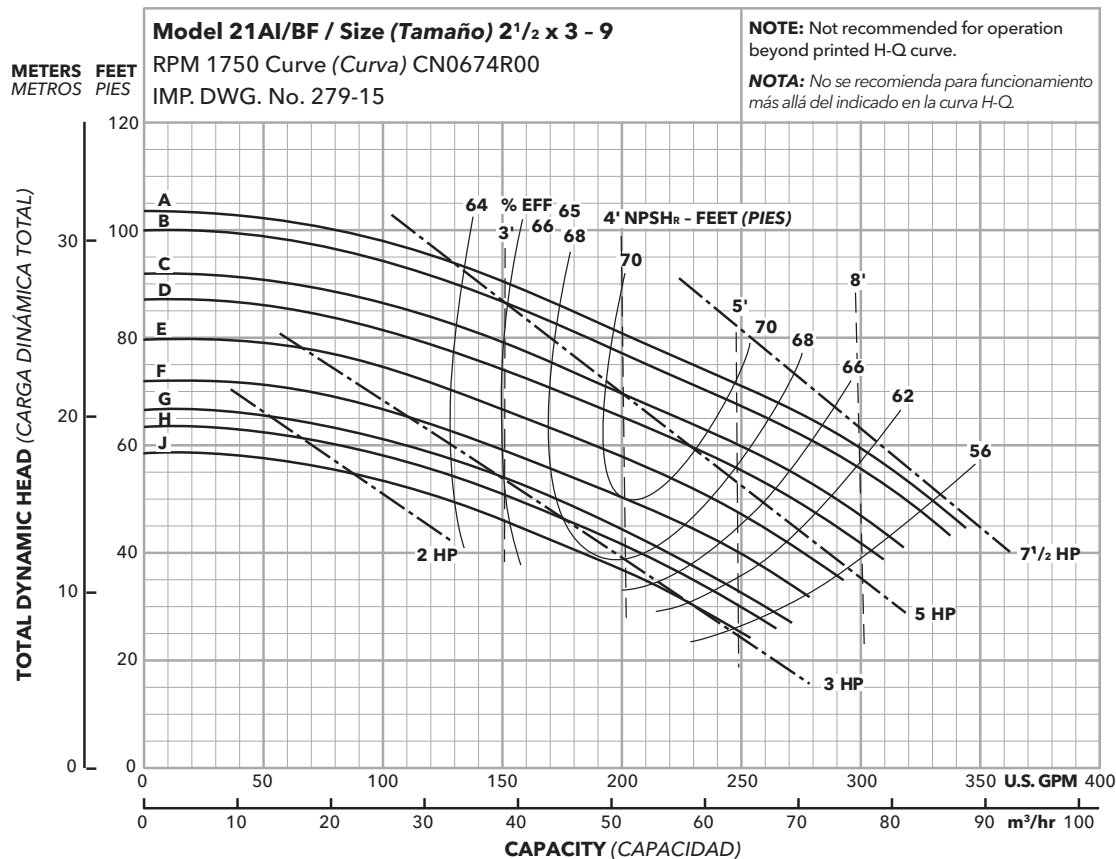

Optional Impeller Impulsor optativo	
Ordering Code Código de pedido	Dia. Diá.
A	10 1/16"
B	9 7/8
C	9 1/2
D	9 1/4
E	8 15/16
F	8 1/2
G	8 3/16
H	8
J	7 1/16

NOTE: Pump will pass a sphere to 5/16" diameter.

NOTA: La bomba dejará pasar una esfera de hasta 5/16 de pulgada de diámetro.

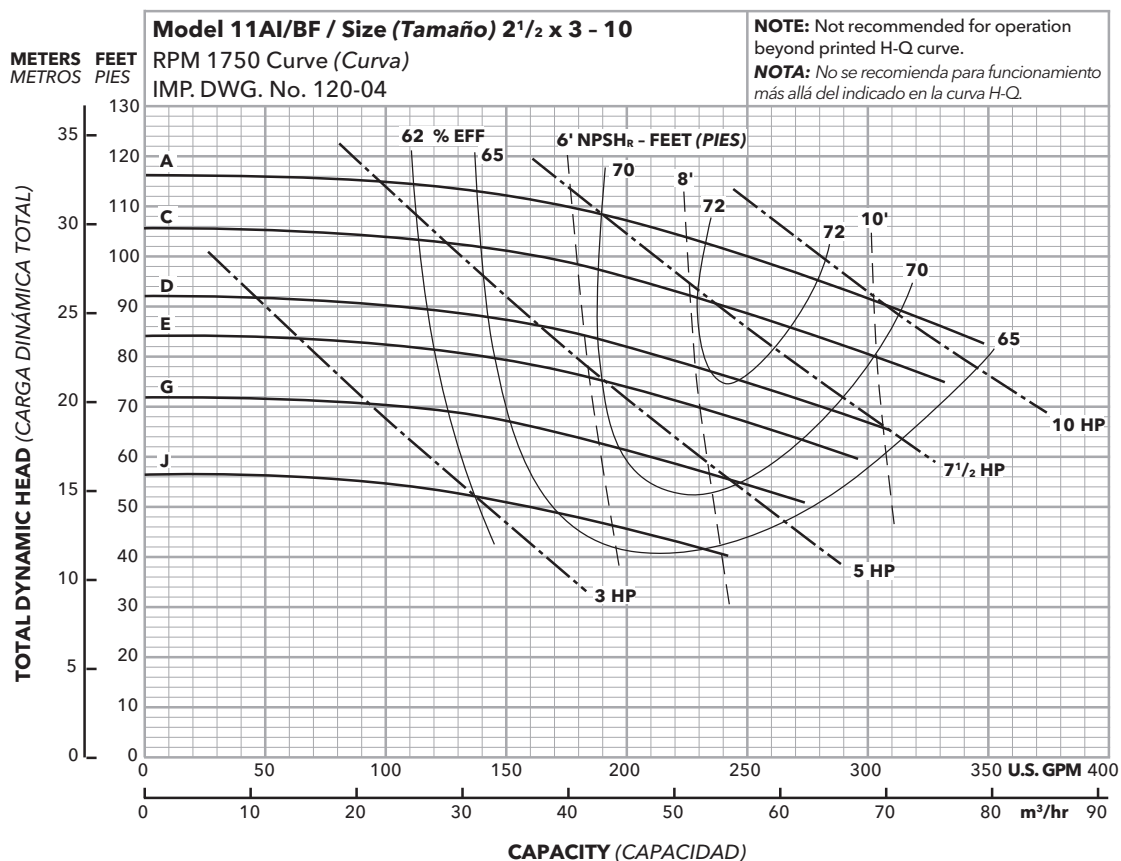

Optional Impeller Impulsor optativo	
Ordering Code Código de pedido	Dia. Diá.
A	10 1/16"
C	9 5/8
D	9
E	8 5/8
G	8
J	7 1/8

NOTE: Pump will pass a sphere to 5/16" diameter.

NOTA: La bomba dejará pasar una esfera de hasta 5/16 de pulgada de diámetro.

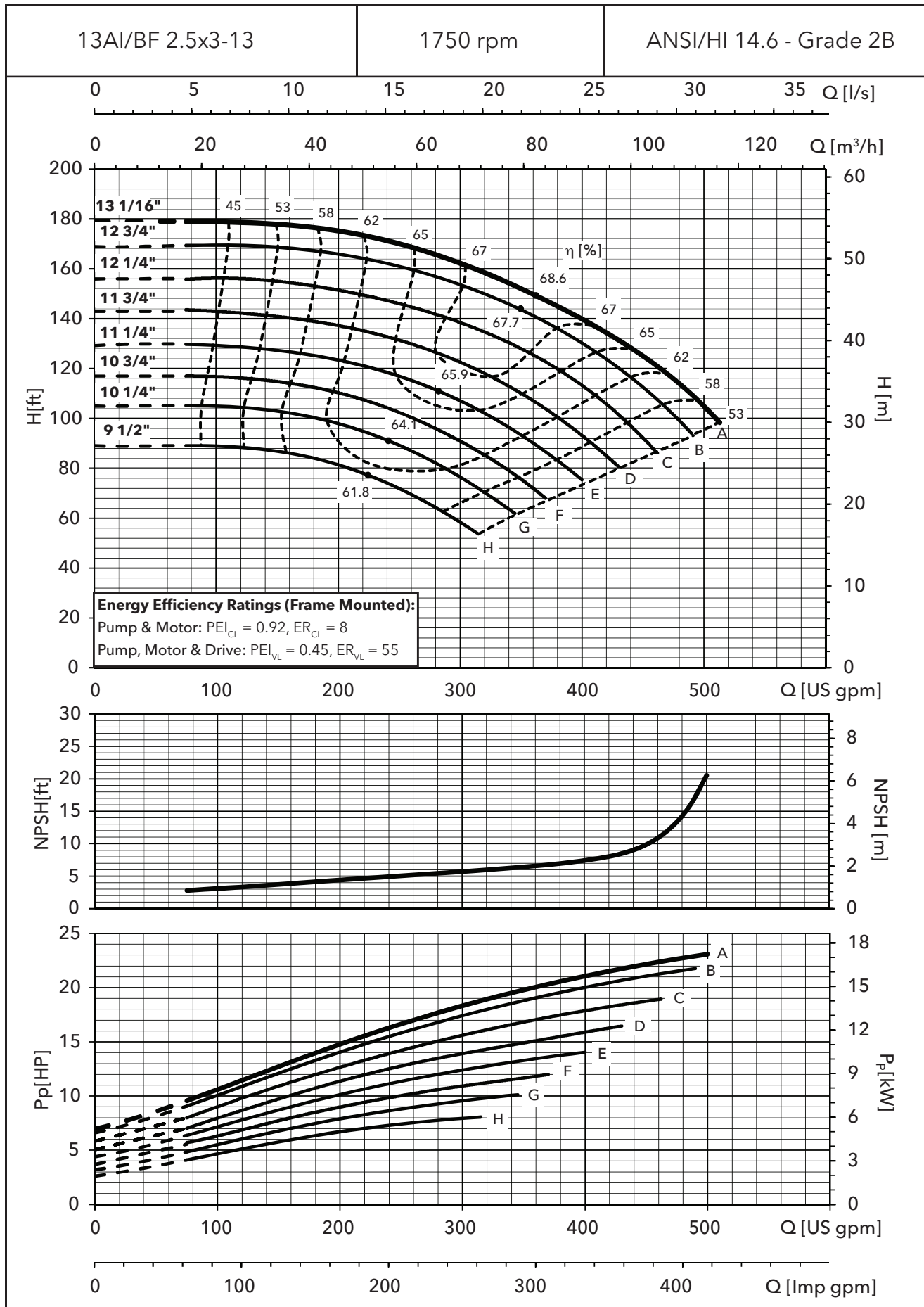

Commercial Water

PERFORMANCE CURVES - 60 HZ, 1750 RPM CURVAS DE DESEMPEÑO - 60 HZ, 1750 RPM

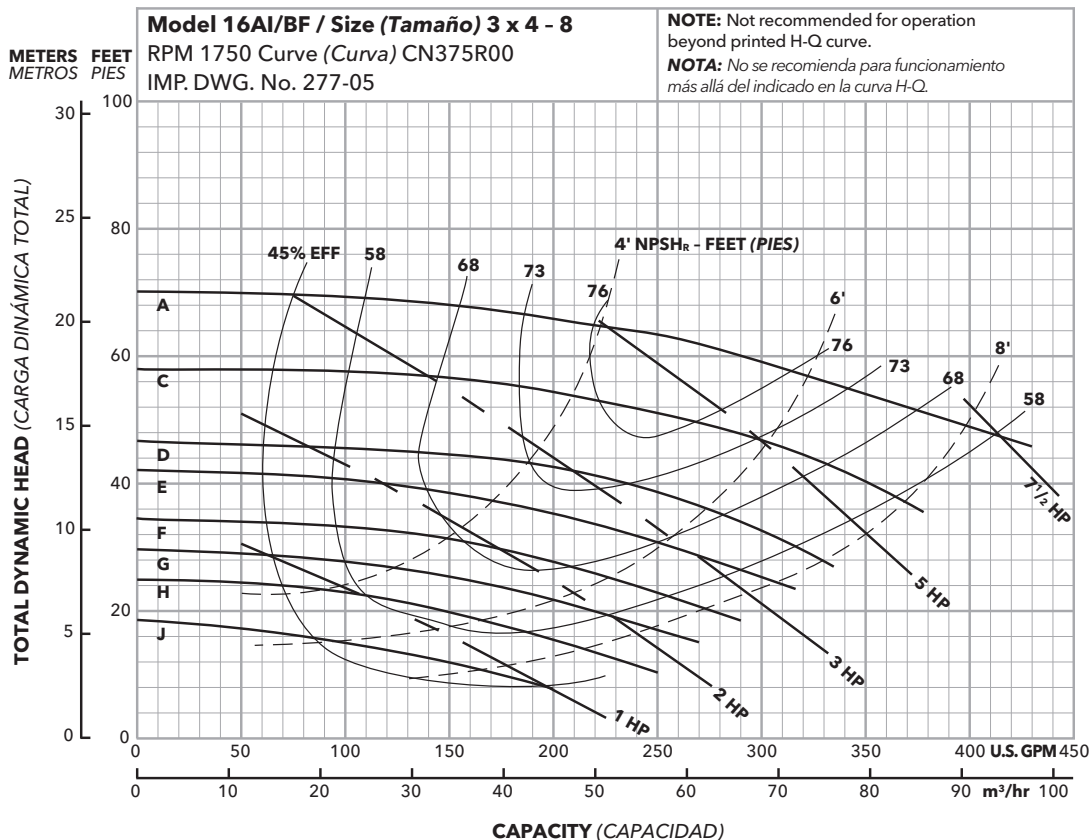

Optional Impeller Impulsor optativo	
Ordering Code Código de pedido	Dia. Diá.
A	8 1/16"
C	7 7/16"
D	6 3/4"
E	6 3/8"
F	5 15/16"
G	5 1/2"
H	5 1/8"
J	4 5/8"

NOTE: Pump will pass a sphere to 3/8" diameter.

NOTA: La bomba dejará pasar una esfera de hasta 3/8 de pulgada de diámetro.

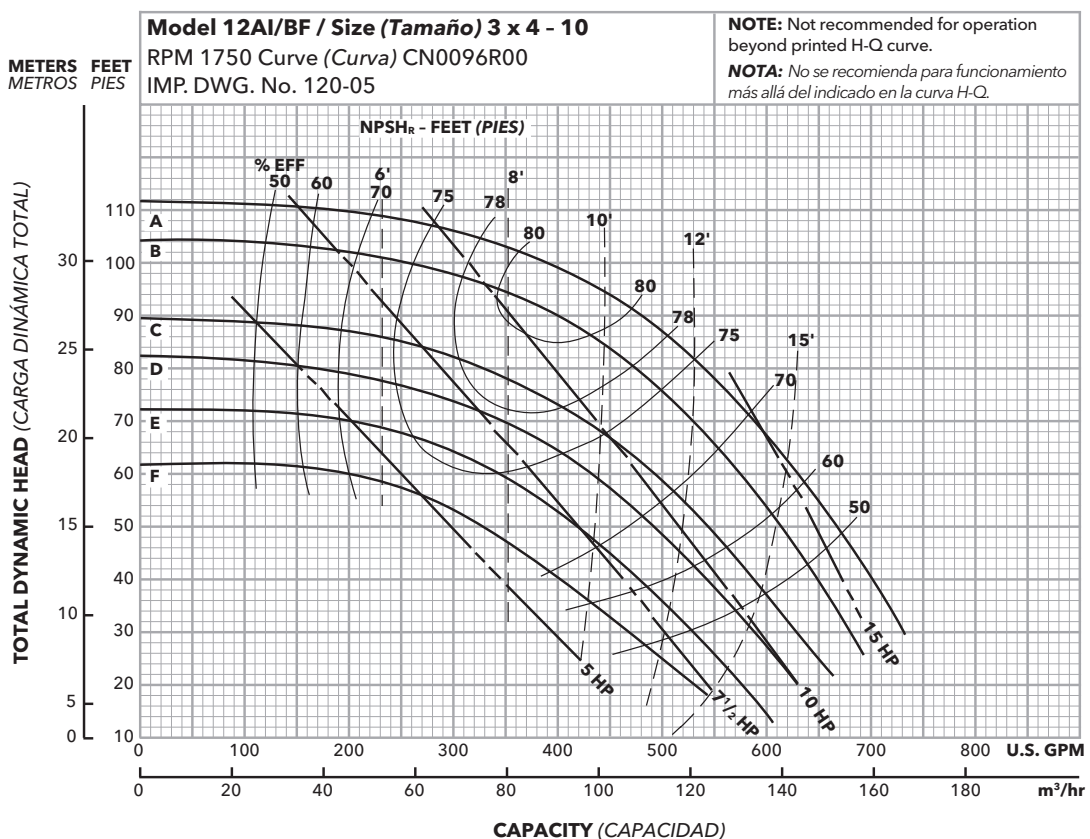

Optional Impeller Impulsor optativo	
Ordering Code Código de pedido	Dia. Diá.
A	10 1/16"
B	9 3/4"
C	9"
D	8 5/8"
E	8 1/8"
F	7 5/8"

NOTE: Pump will pass a sphere to 3/8" diameter.

NOTA: La bomba dejará pasar una esfera de hasta 3/8 de pulgada de diámetro.

PERFORMANCE CURVES - 60 HZ, 1750 RPM CURVAS DE DESEMPEÑO - 60 HZ, 1750 RPM

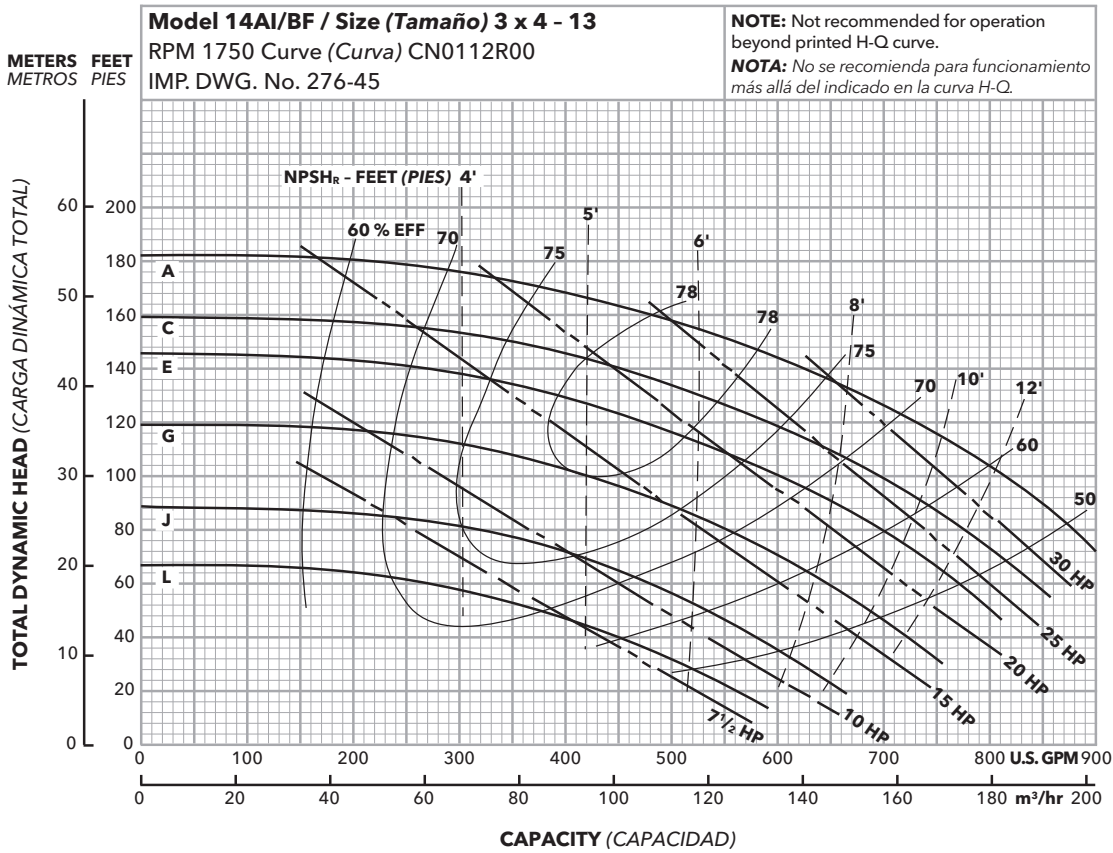

Optional Impeller Impulsor optativo	
Ordering Code Código de pedido	Dia. Diá.
A	13 ¹ / ₁₆ "
C	12 ⁵ / ₁₆
E	11 ³ / ₄
G	10 ³ / ₄
J	9 ¹ / ₈
L	8

NOTE: Pump will pass a sphere to ³/₈" diameter.

NOTA: La bomba dejará pasar una esfera de hasta ³/₈ de pulgada de diámetro.

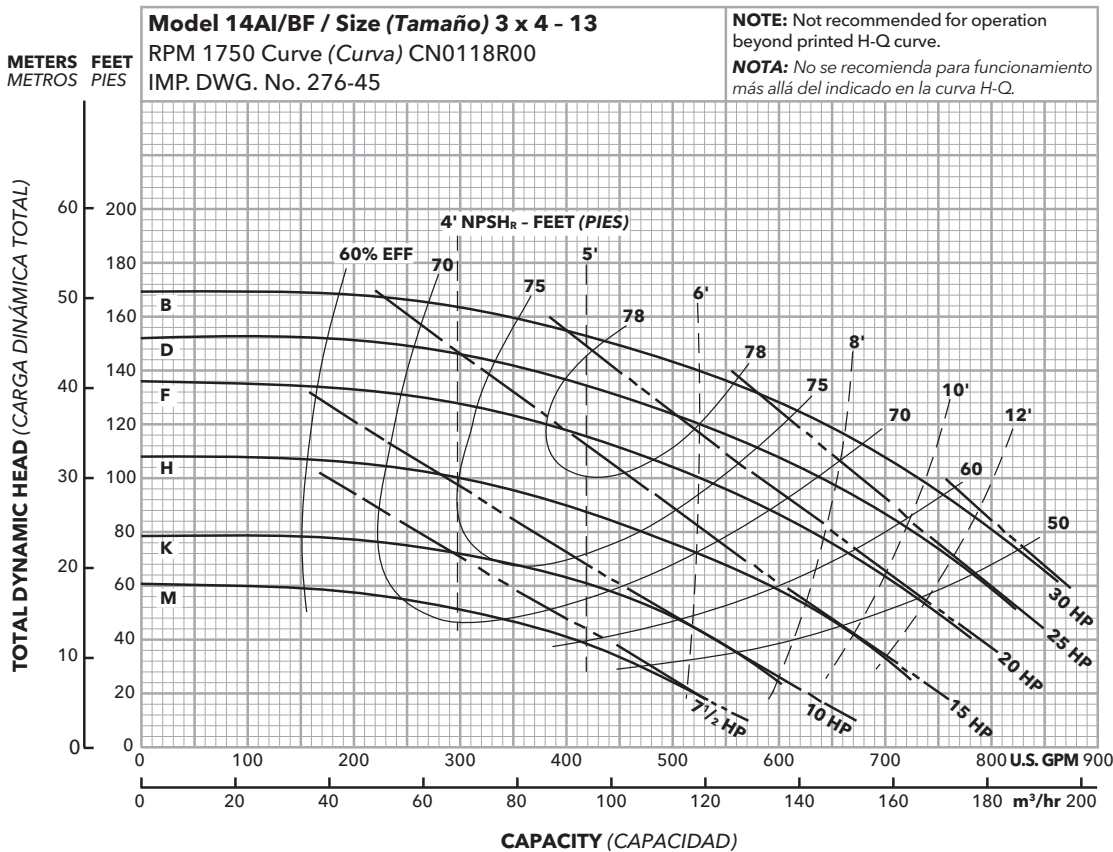

Optional Impeller Impulsor optativo	
Ordering Code Código de pedido	Dia. Diá.
B	12 ⁹ / ₁₆ "
D	12
F	11 ⁵ / ₁₆
H	10 ¹ / ₈
K	8 ¹ / ₁₆
M	7 ¹ / ₁₆

NOTE: Pump will pass a sphere to ³/₈" diameter.

NOTA: La bomba dejará pasar una esfera de hasta ³/₈ de pulgada de diámetro.

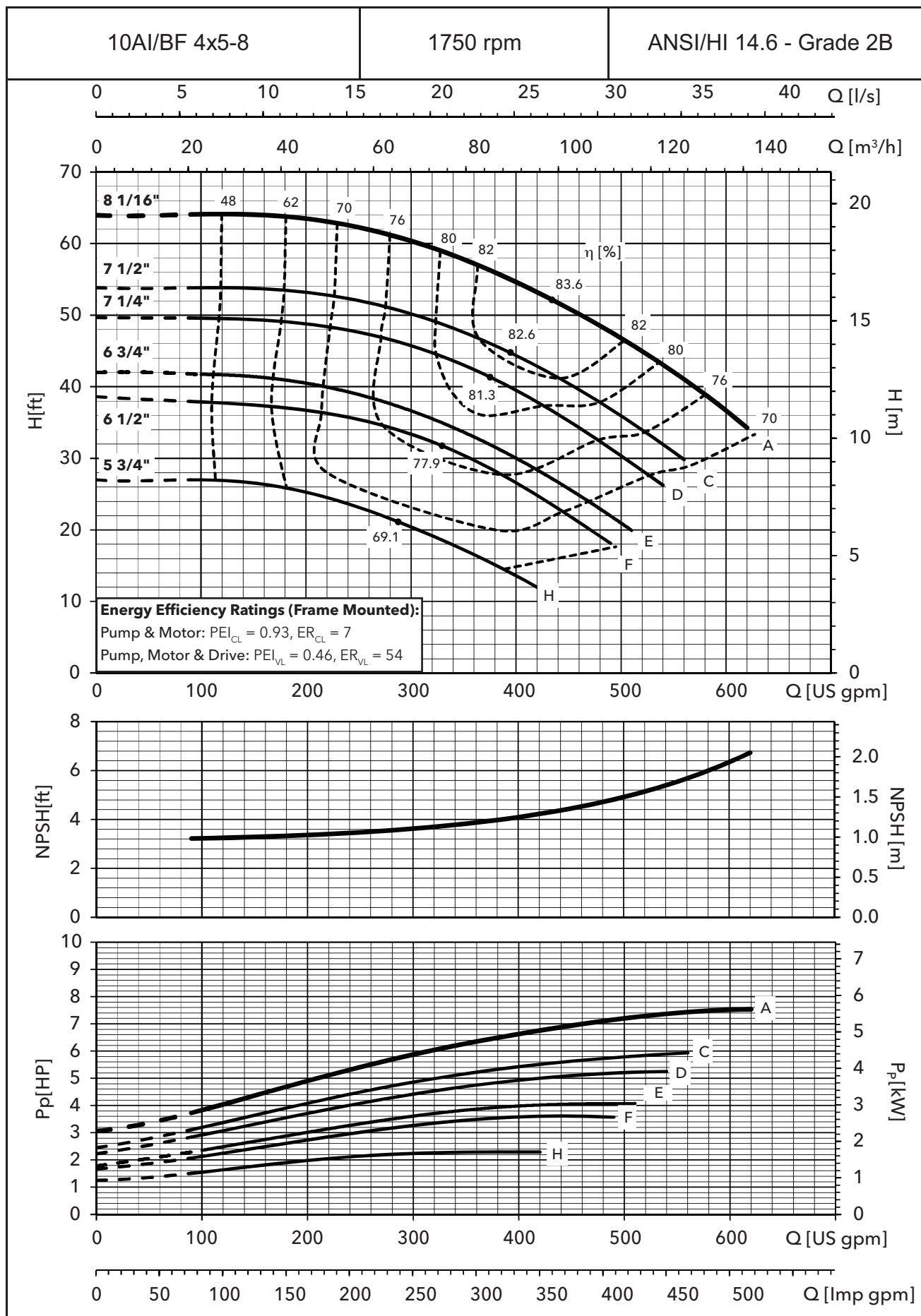

PERFORMANCE CURVES - 60 HZ, 1750 RPM CURVAS DE DESEMPEÑO - 60 HZ, 1750 RPM

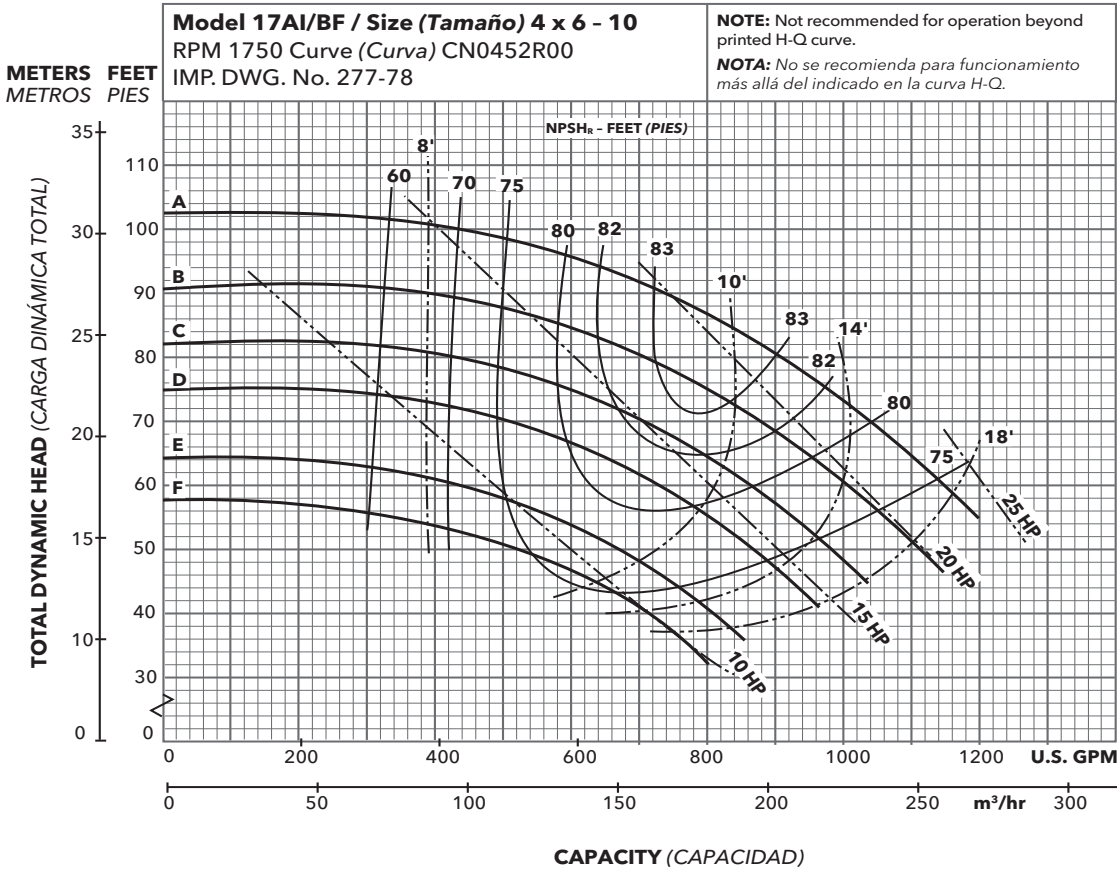

Optional Impeller Impulsor optativo	
Ordering Code Código de pedido	Dia. Diá.
A	10 ¹ / ₁₆ "
B	9 ⁹ / ₁₆ "
C	9 ¹ / ₈ "
D	8 ¹¹ / ₁₆ "
E	8 ¹ / ₈ "
F	7 ³ / ₄ "

NOTE: Pump will pass a sphere to ⁷/₁₆" diameter.

NOTA: La bomba dejará pasar una esfera de hasta ⁷/₁₆ de pulgada de diámetro.

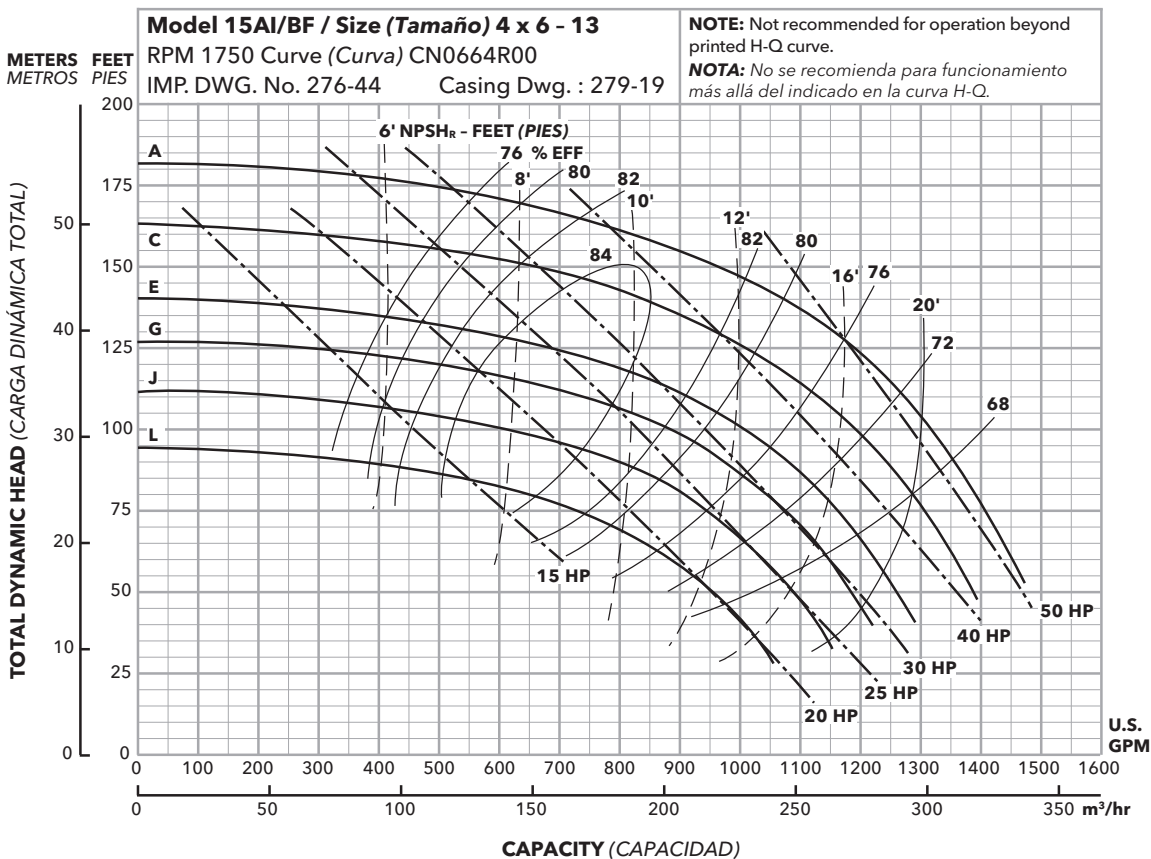

Optional Impeller Impulsor optativo	
Ordering Code Código de pedido	Dia. Diá.
A	12 ⁷ / ₈ "
C	12 ¹ / ₄ "
E	11 ³ / ₈ "
G	10 ⁷ / ₈ "
J	10 ¹ / ₄ "
L	9 ³ / ₈ "

NOTE: Pump will pass a sphere to ⁷/₁₆" diameter.

NOTA: La bomba dejará pasar una esfera de hasta ⁷/₁₆ de pulgada de diámetro.

Commercial Water

PERFORMANCE CURVES - 60 HZ, 1750 RPM CURVAS DE DESEMPEÑO - 60 HZ, 1750 RPM

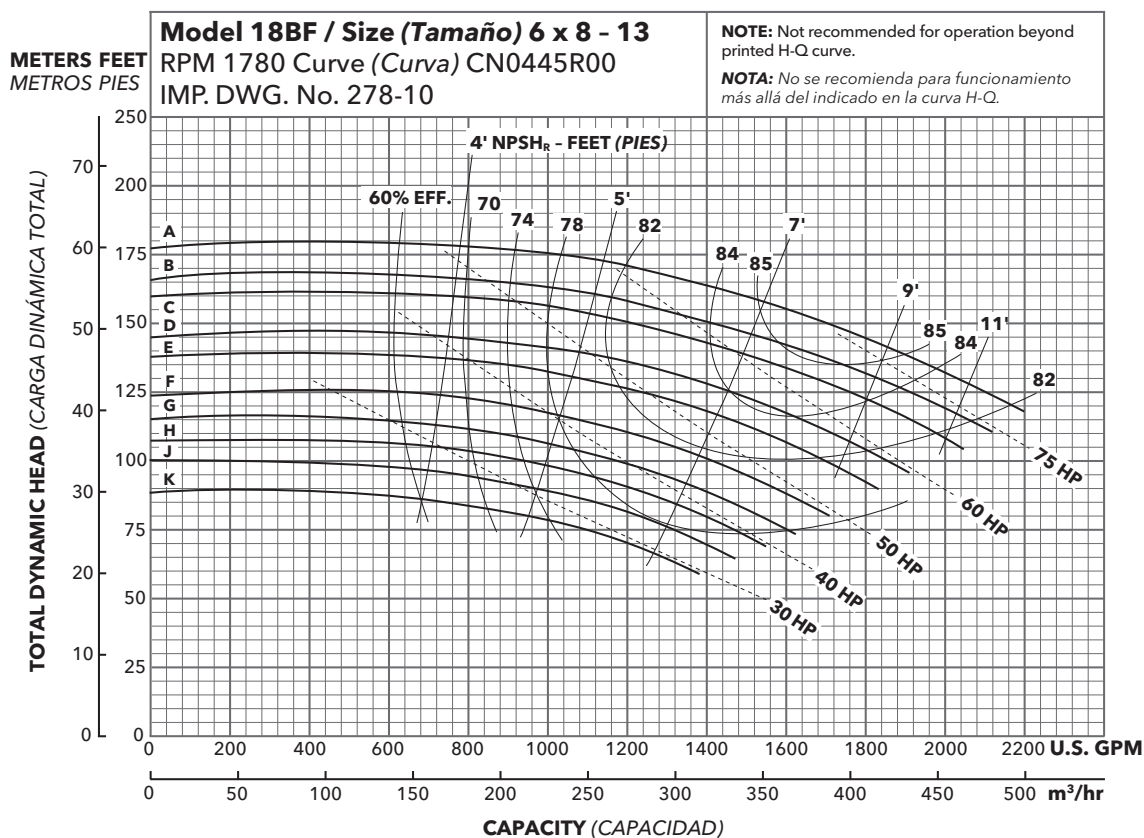
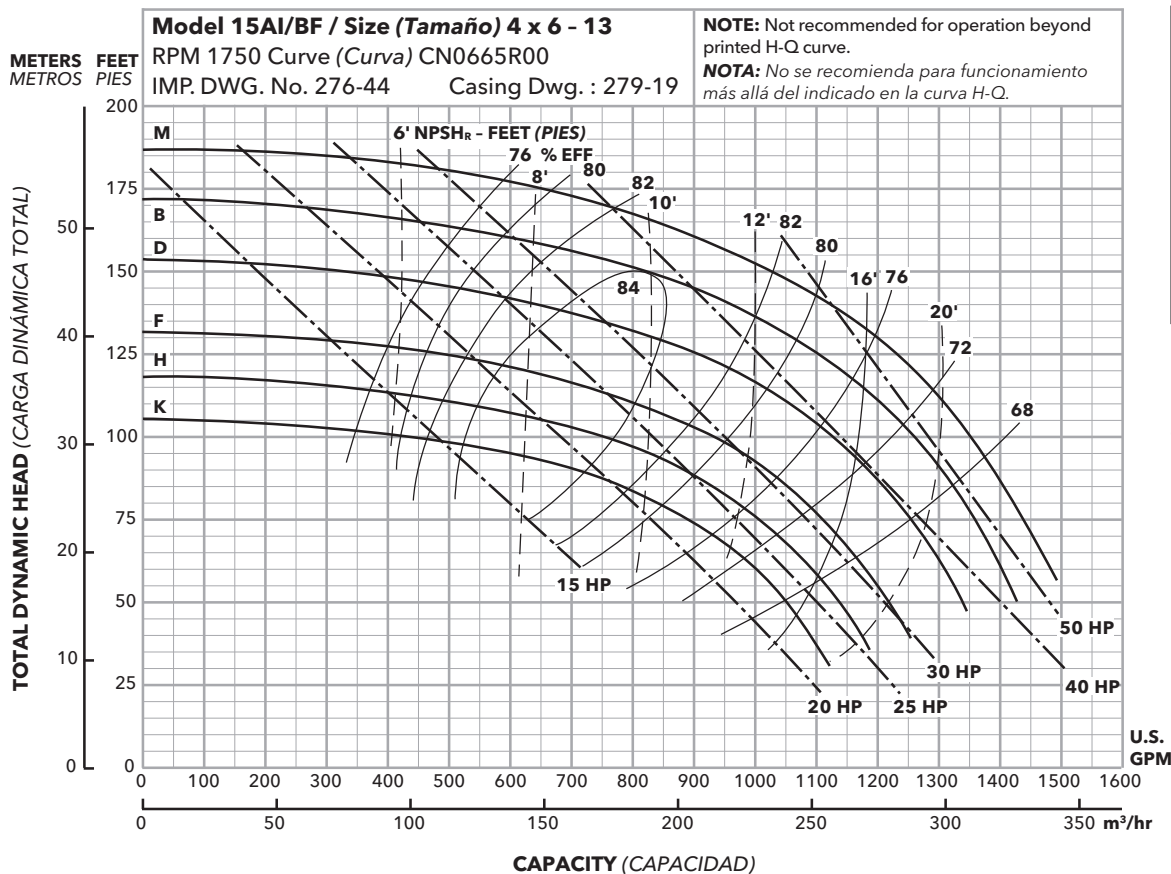

PERFORMANCE CURVES - 60 HZ, 1780 RPM CURVAS DE DESEMPEÑO - 60 HZ, 1780 RPM

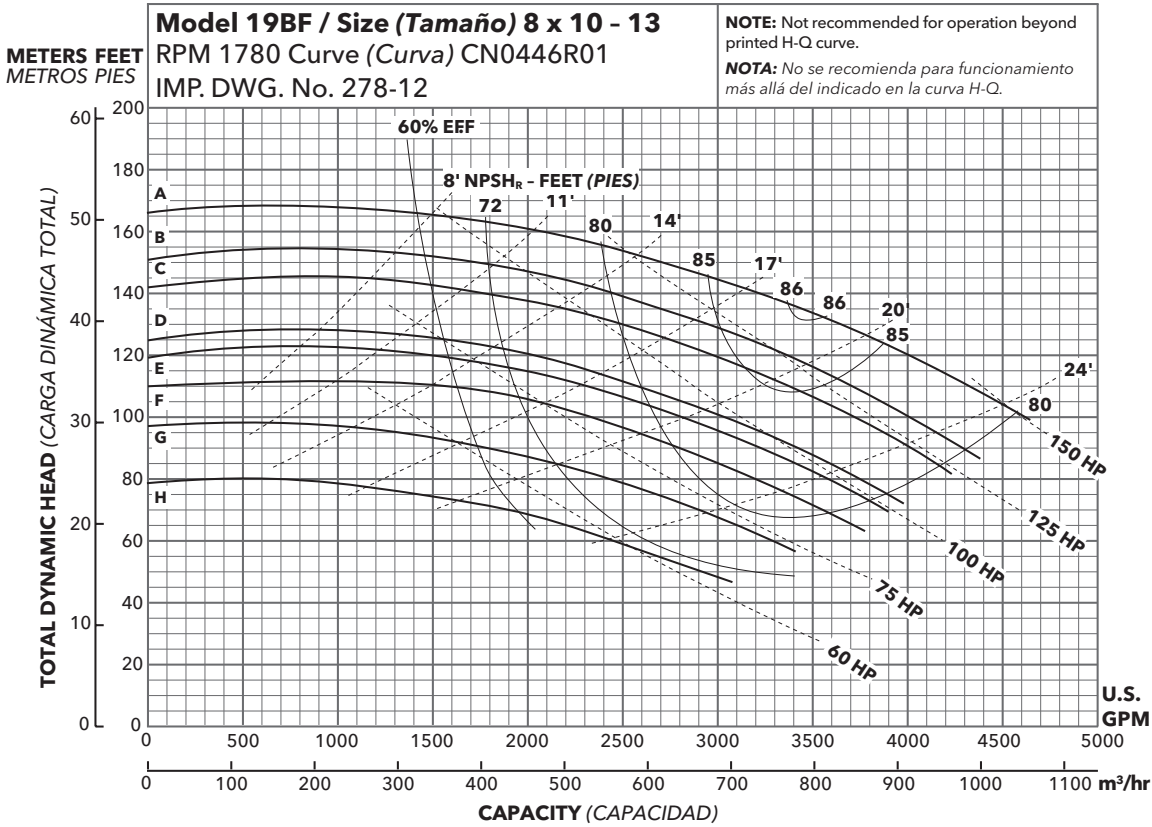

Optional Impeller Impulsor optativo	
Ordering Code Código de pedido	Dia. Diá.
A	13"
B	12 ³ / ₄
C	12 ³ / ₈
D	11 ¹⁵ / ₁₆
E	11 ¹¹ / ₁₆
F	11 ¹ / ₄
G	10 ⁷ / ₈
H	9 ³ / ₁₆

NOTE: Pump will pass a sphere to ⁷/₈" diameter.

NOTA: La bomba dejará pasar una esfera de hasta ⁷/₈ de pulgada de diámetro.

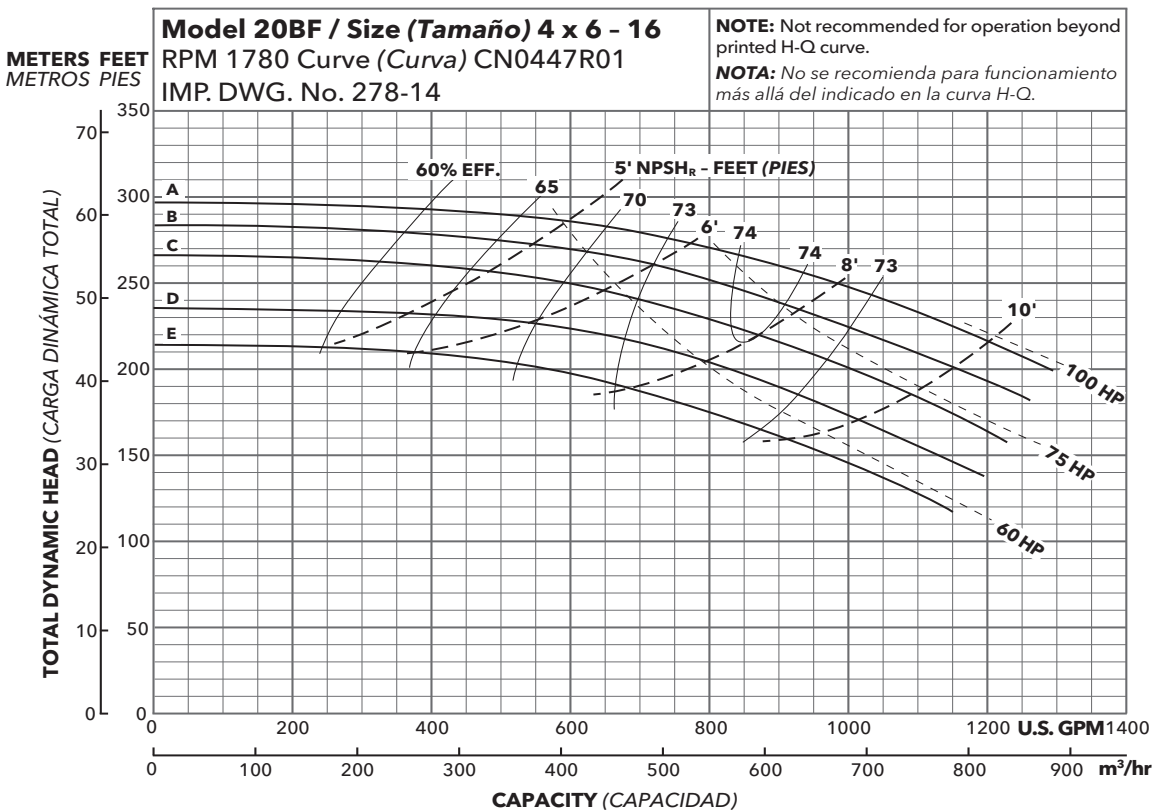

Optional Impeller Impulsor optativo	
Ordering Code Código de pedido	Dia. Diá.
A	16"
B	15 ⁵ / ₈
C	15 ³ / ₁₆
D	14 ¹ / ₂
E	13 ³ / ₄

NOTE: Pump will pass a sphere to ⁵/₈" diameter.

NOTA: La bomba dejará pasar una esfera de hasta ⁵/₈ de pulgada de diámetro.

Commercial Water

PERFORMANCE CURVES - 60 HZ, 1180 RPM CURVAS DE DESEMPEÑO - 60 HZ, 1180 RPM

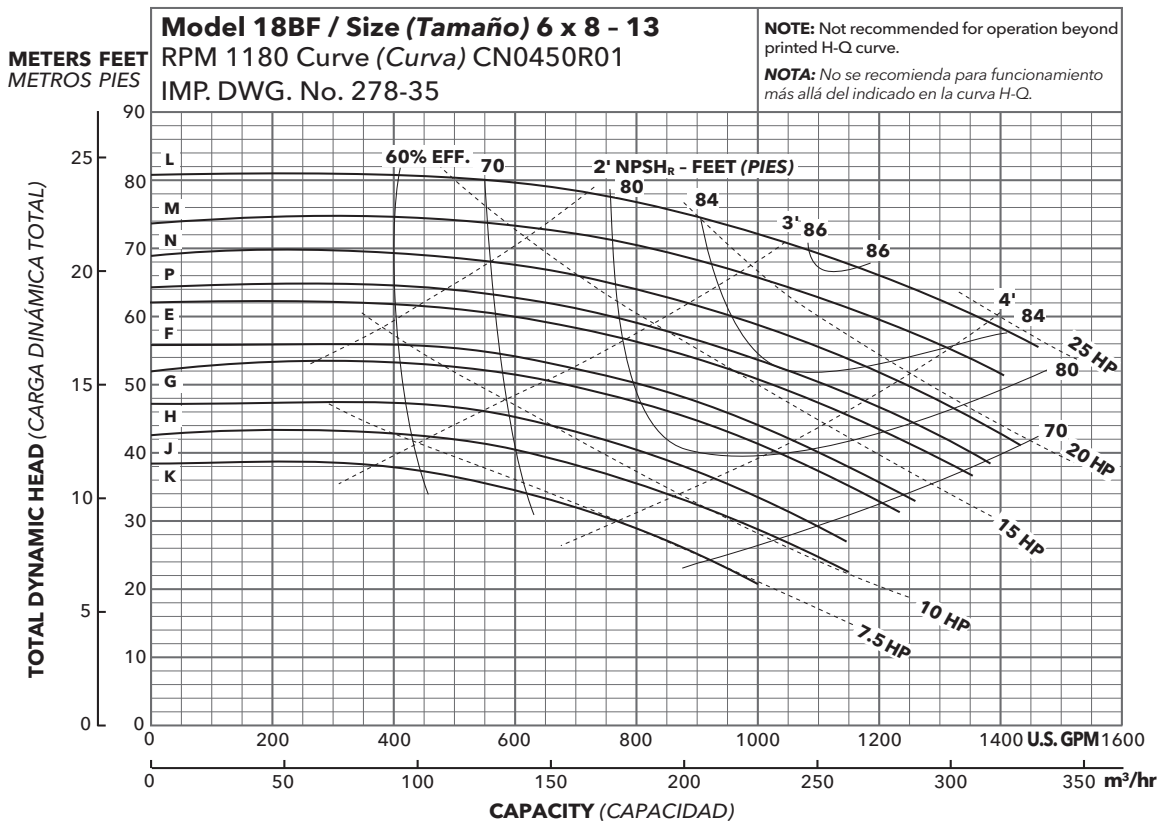

Optional Impeller Impulsor optativo	
Ordering Code Código de pedido	Dia. Diá.
L	13"
M	12½"
N	12⅝"
P	11⅞"
E	11⅝"
F	11⅛"
G	10⅞"
H	10½"
J	10"
K	9½"

NOTE: Pump will pass a sphere to ⅞" diameter.

NOTA: La bomba dejará pasar una esfera de hasta ⅞ de pulgada de diámetro.

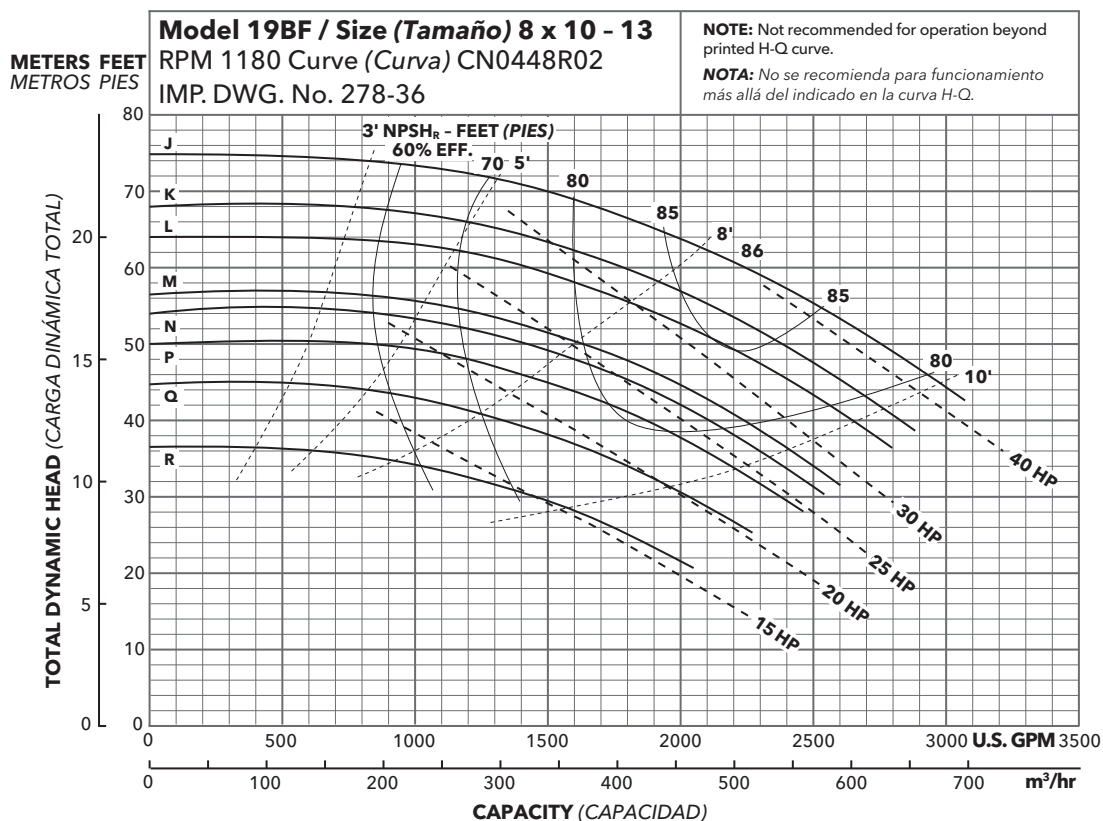

Optional Impeller Impulsor optativo	
Ordering Code Código de pedido	Dia. Diá.
J	13"
K	12¾"
L	12⅞"
M	11⅝"
N	11⅞"
P	11¼"
Q	10⅞"
R	9⅞"

NOTE: Pump will pass a sphere to ⅞" diameter.

NOTA: La bomba dejará pasar una esfera de hasta ⅞ de pulgada de diámetro.

PERFORMANCE CURVES - 50 HZ, 2900 RPM CURVAS DE DESEMPEÑO - 50 HZ, 2900 RPM

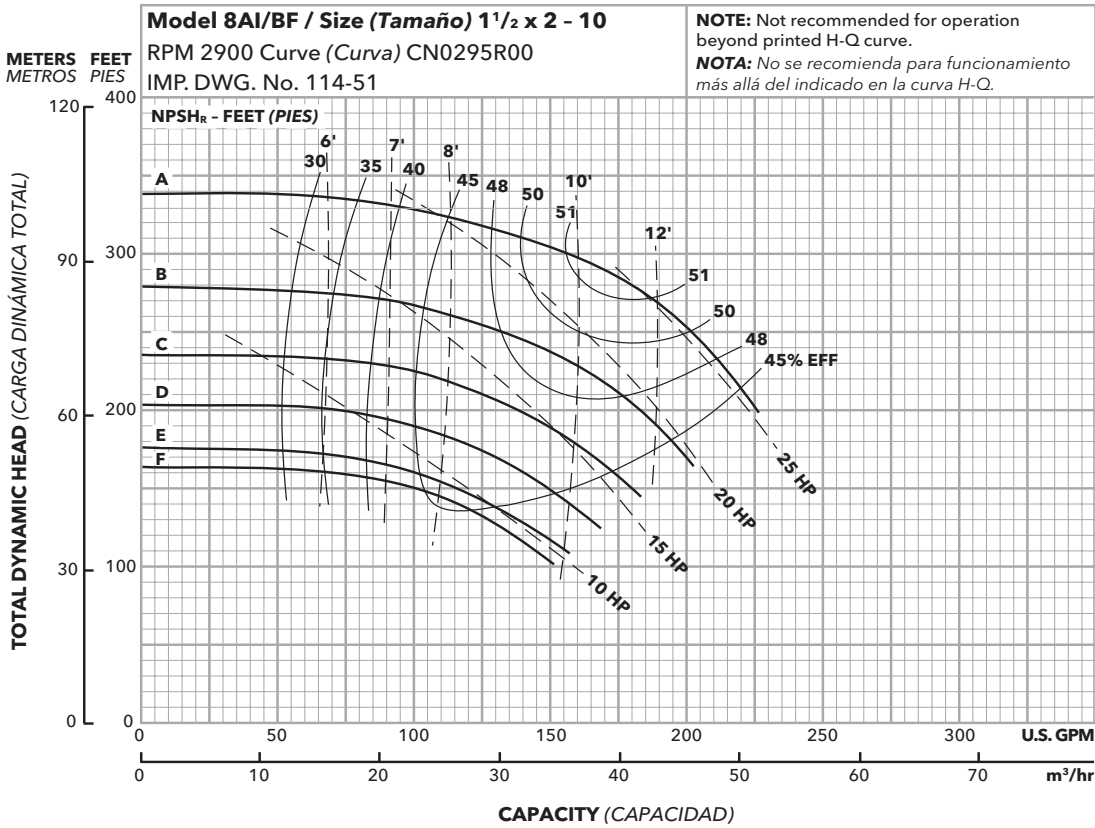

Optional Impeller Impulsor optativo	
Ordering Code Código de pedido	Dia. Diá.
A	10 1/16"
B	9 7/16"
C	8 3/8"
D	7 3/4"
E	7 1/4"
F	7"

NOTE: Pump will pass a sphere to 5/32" diameter.

NOTA: La bomba dejará pasar una esfera de hasta 5/32 de pulgada de diámetro.

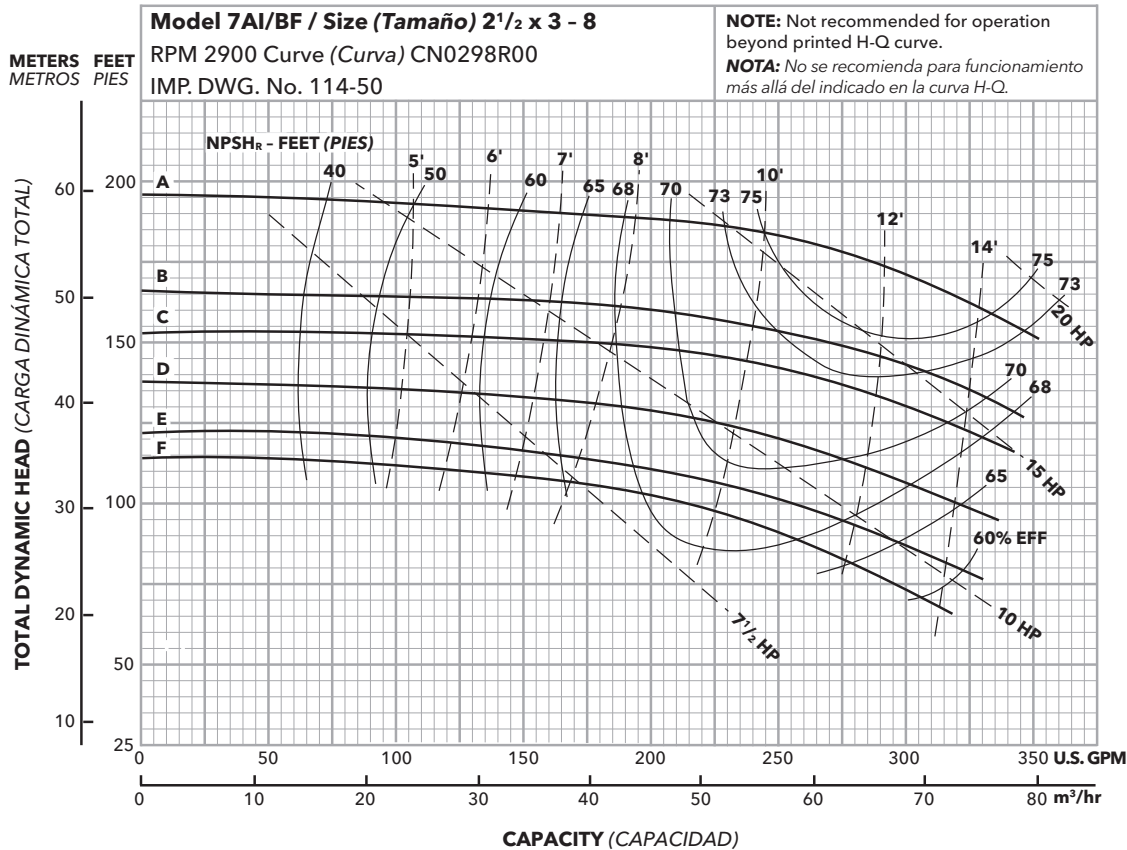

Optional Impeller Impulsor optativo	
Ordering Code Código de pedido	Dia. Diá.
A	7 15/16"
B	7 7/16"
C	7 3/16"
D	6 13/16"
E	6 3/8"
F	6 3/16"

NOTE: Pump will pass a sphere to 5/16" diameter.

NOTA: La bomba dejará pasar una esfera de hasta 5/16 de pulgada de diámetro.

Commercial Water

PERFORMANCE CURVES - 50 HZ, 2900 RPM CURVAS DE DESEMPEÑO - 50 HZ, 2900 RPM

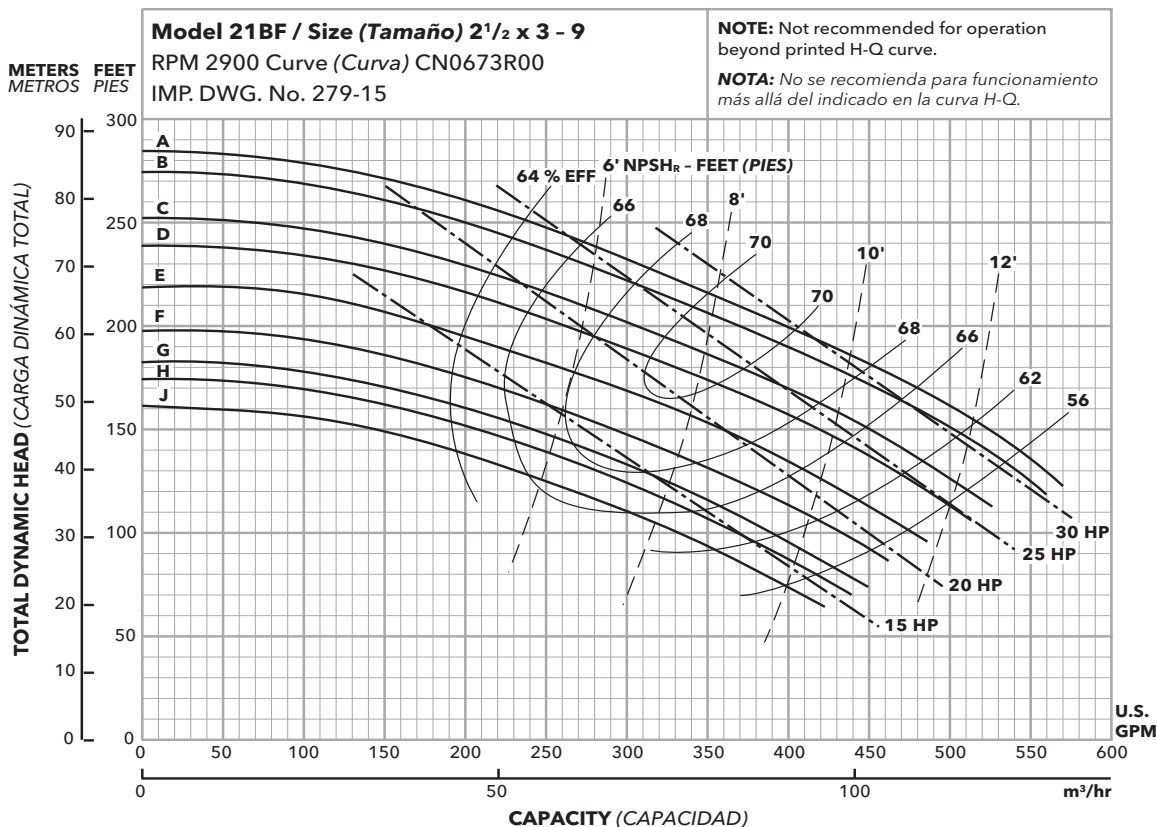

Optional Impeller Impulsor optativo	
Ordering Code Código de pedido	Dia. Diá.
A	10 1/16"
B	9 7/8
C	9 1/2
D	9 1/4
E	8 5/16
F	8 1/2
G	8 3/16
H	8
J	7 1/16

NOTE: Pump will pass a sphere to 5/16" diameter.

NOTA: La bomba dejará pasar una esfera de hasta 3/8 de pulgada de diámetro.

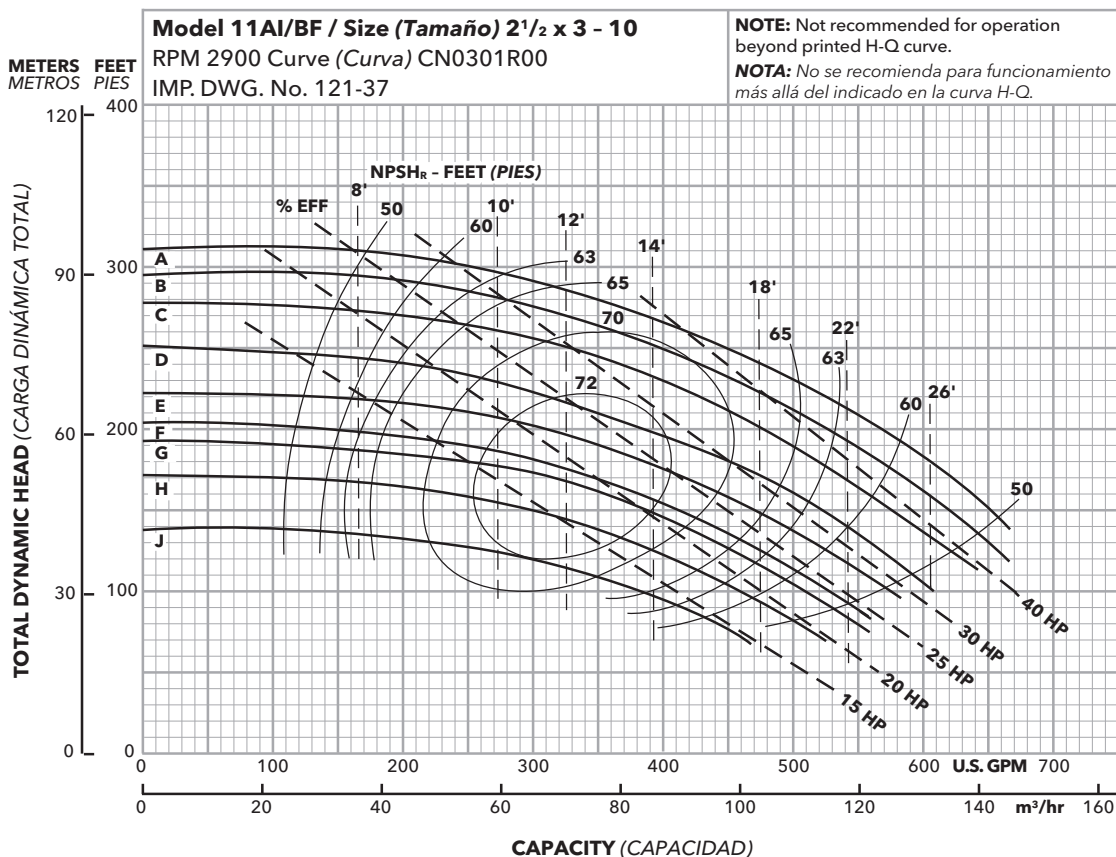

Optional Impeller Impulsor optativo	
Ordering Code Código de pedido	Dia. Diá.
A	10 1/16"
B	9 7/8
C	9 5/8
D	9
E	8 5/8
F	8 1/4
G	8
H	7 5/8
J	7 1/8

NOTE: Pump will pass a sphere to 5/16" diameter.

NOTA: La bomba dejará pasar una esfera de hasta 3/8 de pulgada de diámetro.

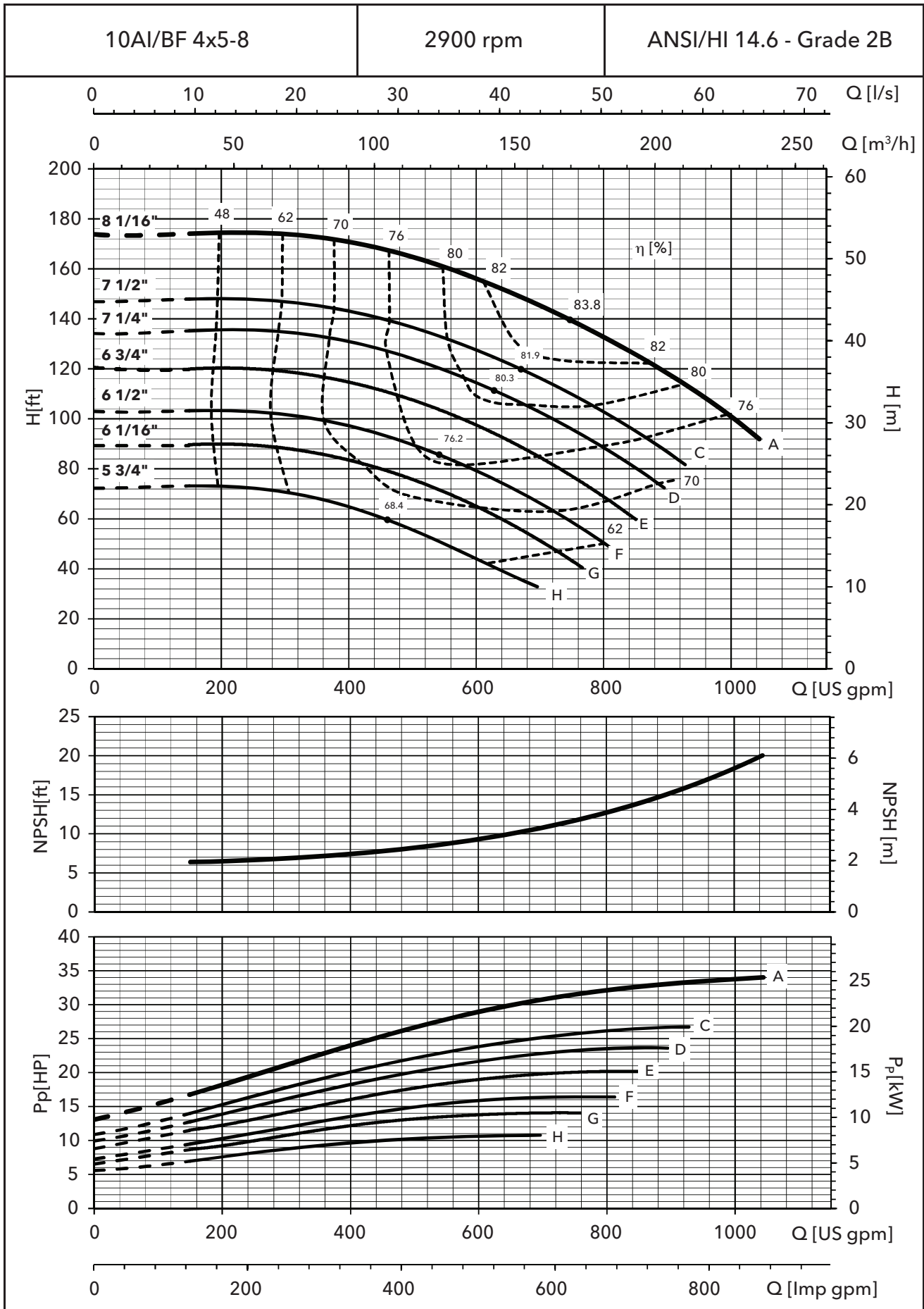

Commercial Water

PERFORMANCE CURVES - 50 HZ, 2900 RPM CURVAS DE DESEMPEÑO - 50 HZ, 2900 RPM

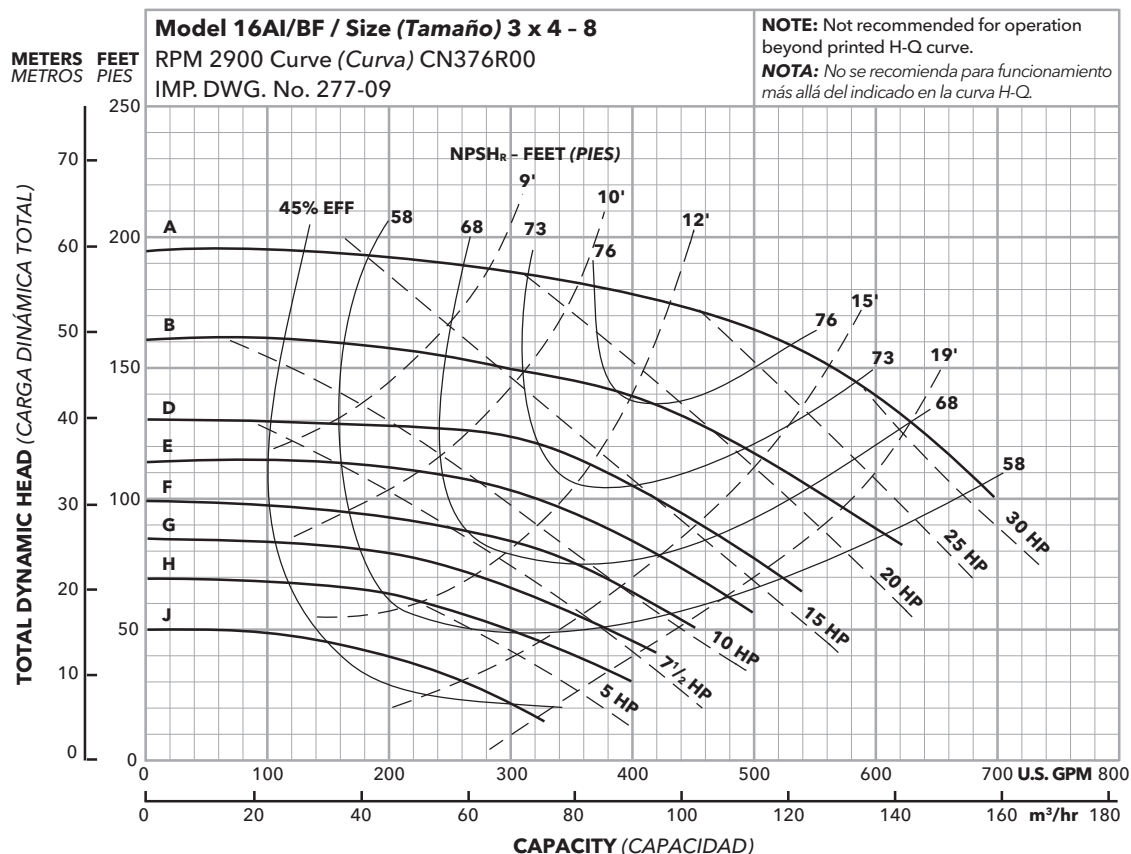

Optional Impeller Impulsor optativo	
Ordering Code Código de pedido	Dia. Diá.
A	8 1/16"
B	7 7/16"
D	6 3/4"
E	6 3/8"
F	5 15/16"
G	5 1/2"
H	5 1/8"
J	4 5/8"

NOTE: Pump will pass a sphere to 5/16" diameter.

NOTA: La bomba dejará pasar una esfera de hasta 5/16 de pulgada de diámetro.

PERFORMANCE CURVES - 50 HZ, 1450 RPM CURVAS DE DESEMPEÑO - 50 HZ, 1450 RPM

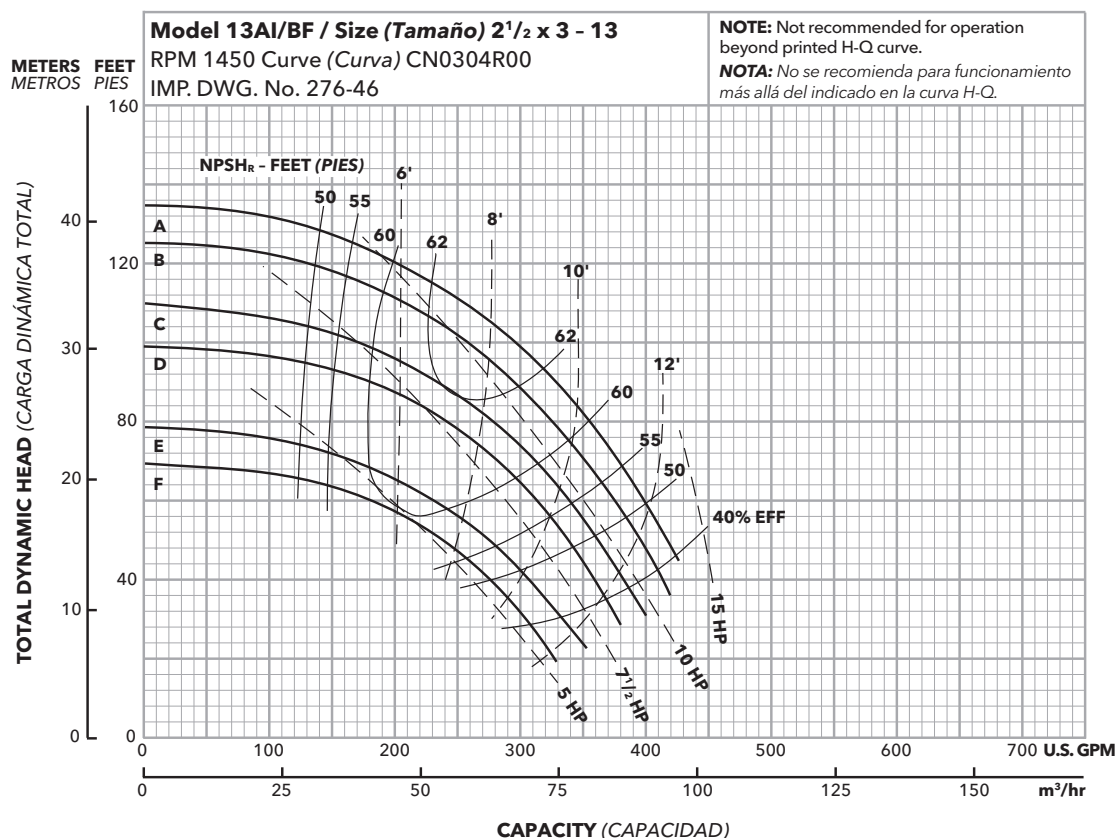

Optional Impeller Impulsor optativo	
Ordering Code Código de pedido	Dia. Diá.
A	13 1/16"
B	12 3/4"
C	11 7/8"
D	11 3/8"
E	9 7/8"
F	9 3/8"

NOTE: Pump will pass a sphere to 5/16" diameter.

NOTA: La bomba dejará pasar una esfera de hasta 5/16 de pulgada de diámetro.

PERFORMANCE CURVES - 50 HZ, 1450 RPM CURVAS DE DESEMPEÑO - 50 HZ, 1450 RPM

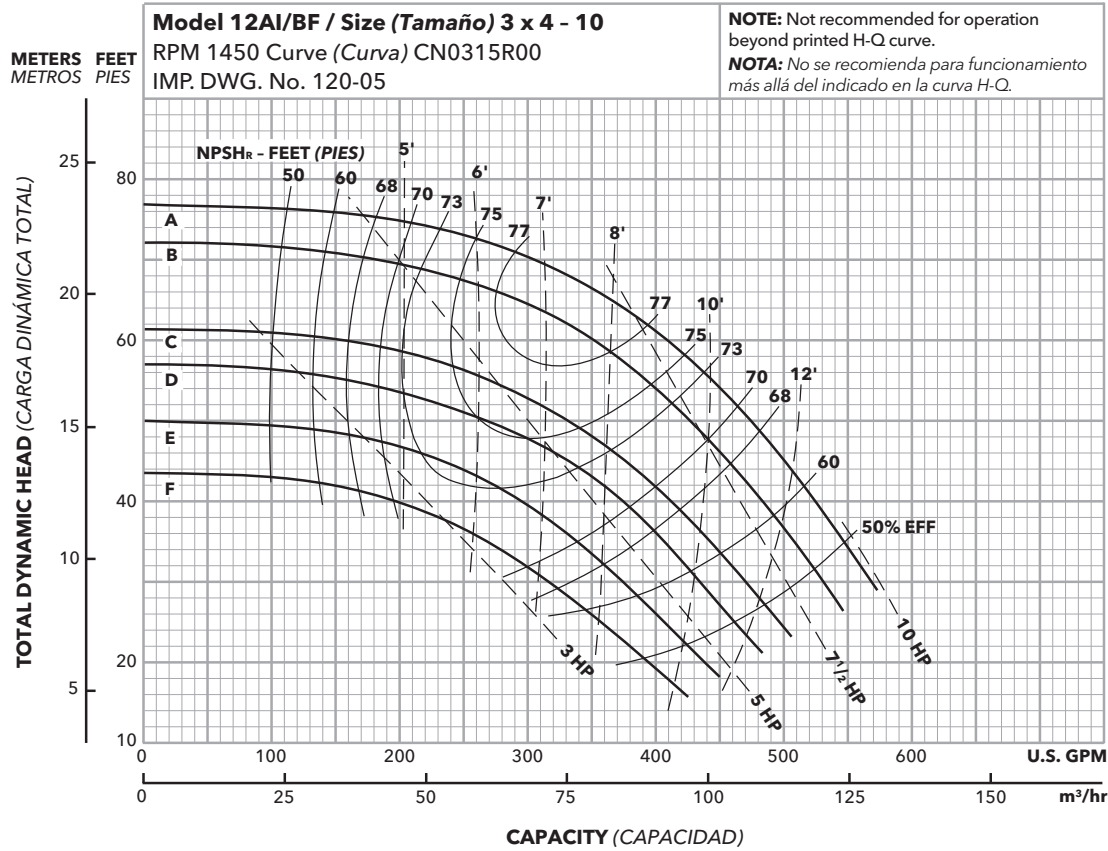

Optional Impeller Impulsor optativo	
Ordering Code Código de pedido	Dia. Diá.
A	10 1/16"
B	9 3/4"
C	9"
D	8 5/8"
E	8 1/8"
F	7 5/8"

NOTE: Pump will pass a sphere to 3/8" diameter.

NOTA: La bomba dejará pasar una esfera de hasta 3/8 de pulgada de diámetro.

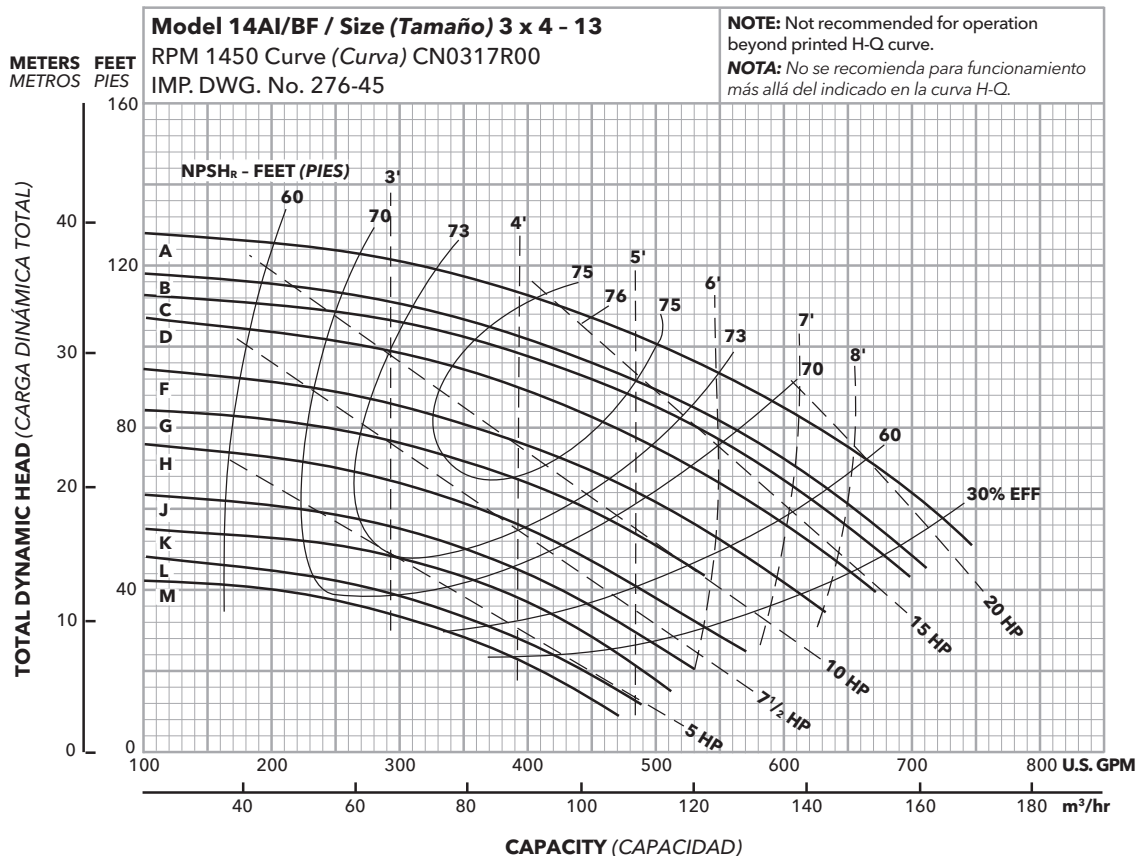

Optional Impeller Impulsor optativo	
Ordering Code Código de pedido	Dia. Diá.
A	13 1/16"
B	12 5/16"
C	12 3/16"
D	12"
F	11 5/16"
G	10 3/4"
H	10 1/8"
J	9 1/8"
K	8 1/16"
L	8"
M	7 1/16"

NOTE: Pump will pass a sphere to 3/8" diameter.

NOTA: La bomba dejará pasar una esfera de hasta 3/8 de pulgada de diámetro.

Commercial Water

PERFORMANCE CURVES - 50 HZ, 1450 RPM CURVAS DE DESEMPEÑO - 50 HZ, 1450 RPM

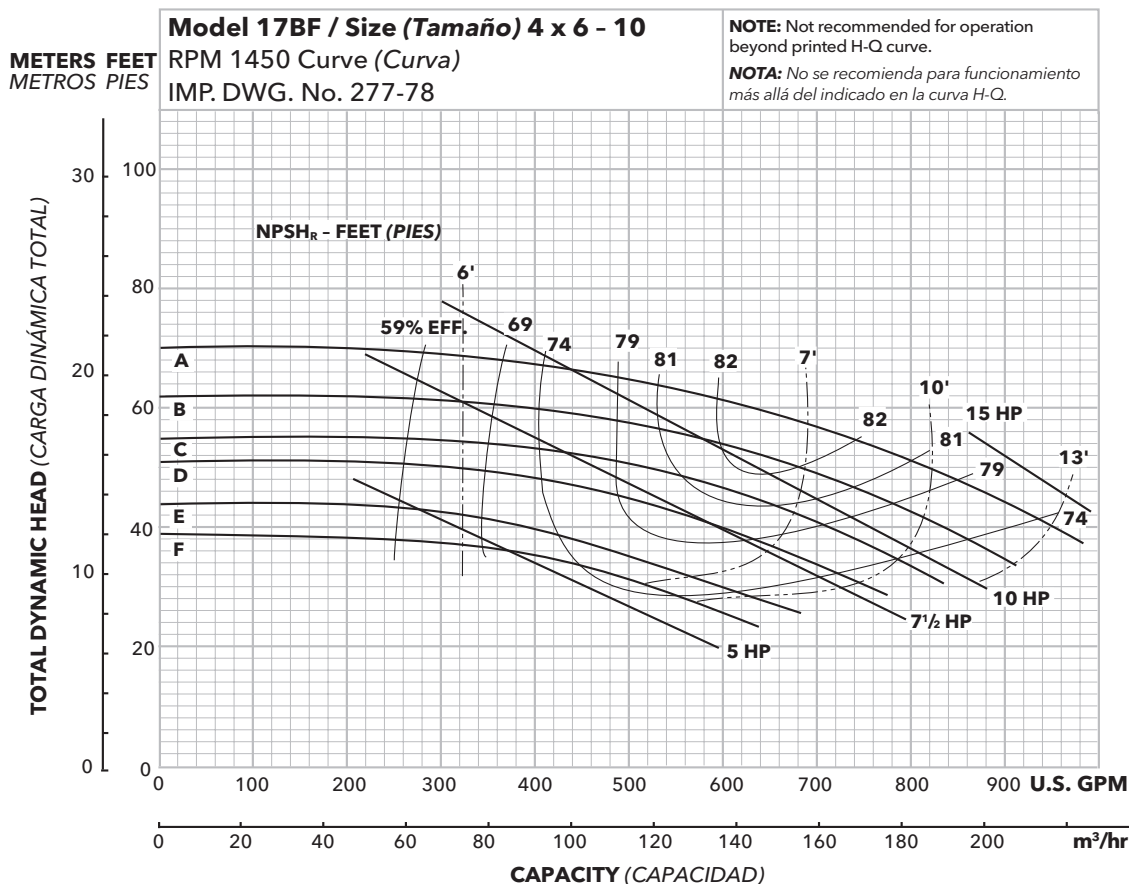

Optional Impeller Impulsor optativo	
Ordering Code Código de pedido	Dia. Diá.
A	10 ¹ / ₁₆ "
B	9 ¹ / ₁₆ "
C	9 ¹ / ₈ "
D	8 ¹ / ₁₆ "
E	8 ¹ / ₈ "
F	7 ³ / ₄ "

NOTE: Pump will pass a sphere to ⁷/₁₆" diameter.

NOTA: La bomba dejará pasar una esfera de hasta ⁷/₁₆ de pulgada de diámetro.

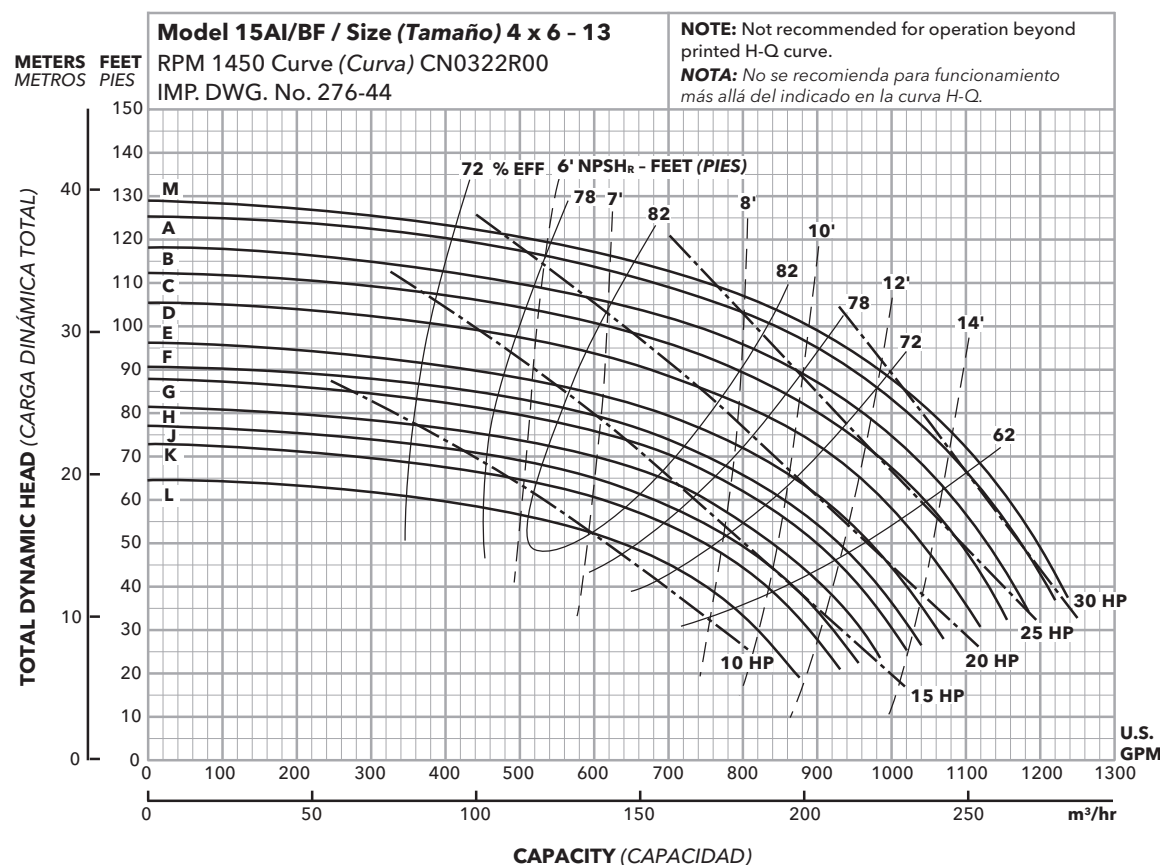

Optional Impeller Impulsor optativo	
Ordering Code Código de pedido	Dia. Diá.
M	13 ¹ / ₁₆ "
A	12 ⁷ / ₈ "
B	12 ¹ / ₂ "
C	12 ¹ / ₄ "
D	11 ⁷ / ₈ "
E	11 ³ / ₈ "
F	11 ¹ / ₁₆ "
G	10 ⁷ / ₈ "
H	10 ¹ / ₂ "
J	10 ¹ / ₄ "
K	9 ⁷ / ₈ "
L	9 ³ / ₈ "

NOTE: Pump will pass a sphere to ⁷/₁₆" diameter.

NOTA: La bomba dejará pasar una esfera de hasta ⁷/₁₆ de pulgada de diámetro.

PERFORMANCE CURVES - 50 HZ, 1450 RPM CURVAS DE DESEMPEÑO - 50 HZ, 1450 RPM

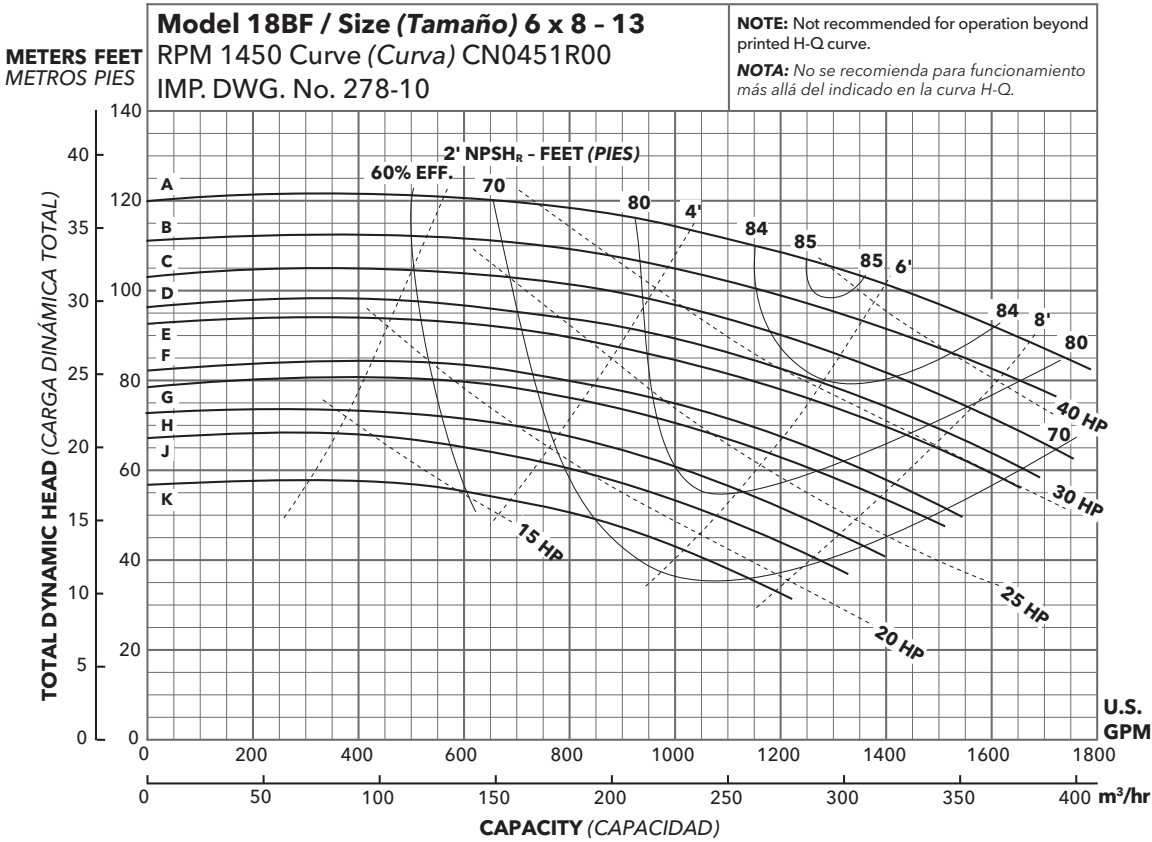

Optional Impeller
Impulsor optativo

Ordering Code Código de pedido	Dia. Diá.
A	13"
B	12 $\frac{1}{2}$ "
C	12 $\frac{5}{16}$ "
D	11 $\frac{7}{8}$ "
E	11 $\frac{5}{8}$ "
F	11 $\frac{1}{8}$ "
G	10 $\frac{7}{8}$ "
H	10 $\frac{1}{2}$ "
J	10"
K	9 $\frac{1}{2}$ "

NOTE: Pump will pass a sphere to $\frac{7}{8}$ " diameter.

NOTA: La bomba dejará pasar una esfera de hasta $\frac{7}{8}$ de pulgada de diámetro.

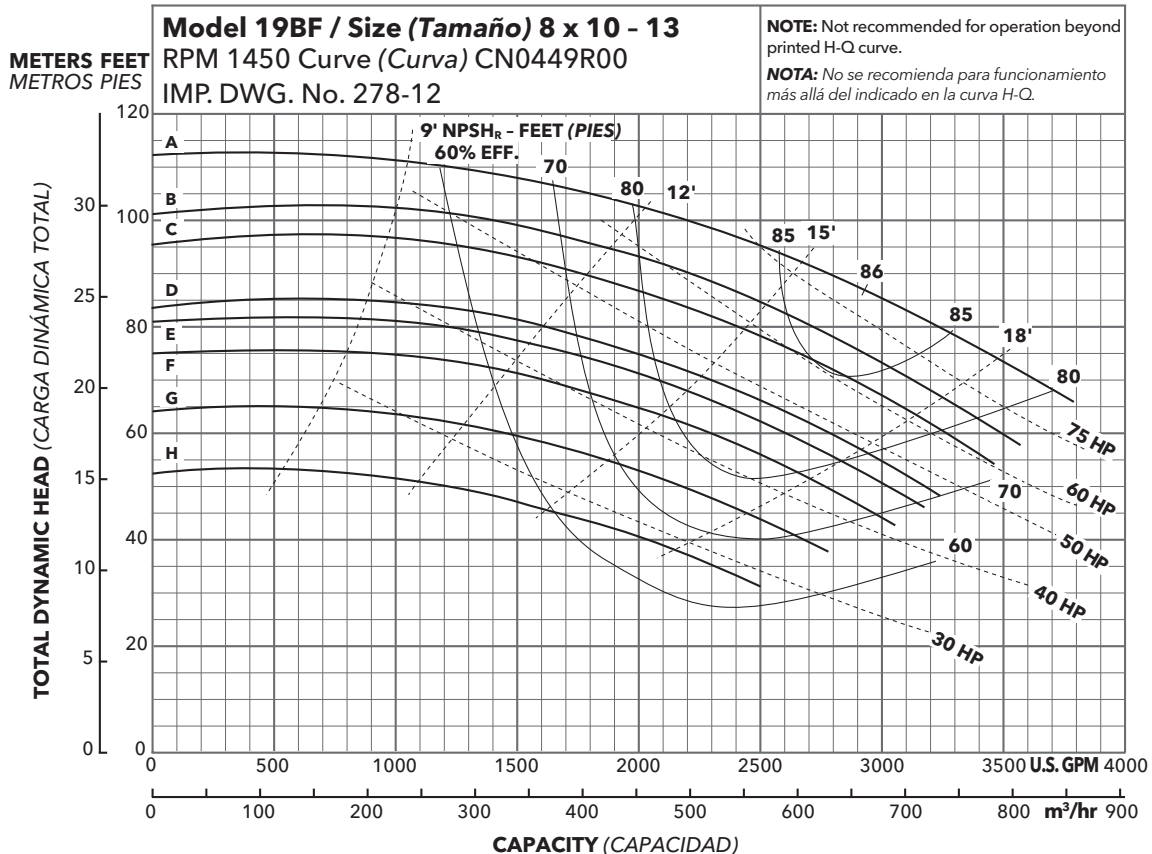

Optional Impeller
Impulsor optativo

Ordering Code Código de pedido	Dia. Diá.
A	13"
B	12 $\frac{3}{4}$ "
C	12 $\frac{3}{8}$ "
D	11 $\frac{15}{16}$ "
E	11 $\frac{11}{16}$ "
F	11 $\frac{1}{4}$ "
G	10 $\frac{7}{8}$ "
H	9 $\frac{3}{16}$ "

NOTE: Pump will pass a sphere to $\frac{7}{16}$ " diameter.

NOTA: La bomba dejará pasar una esfera de hasta $\frac{7}{16}$ de pulgada de diámetro.

PERFORMANCE CURVES - VARIABLE SPEED CURVAS DE DESEMPEÑO - VELOCIDAD VARIABLE

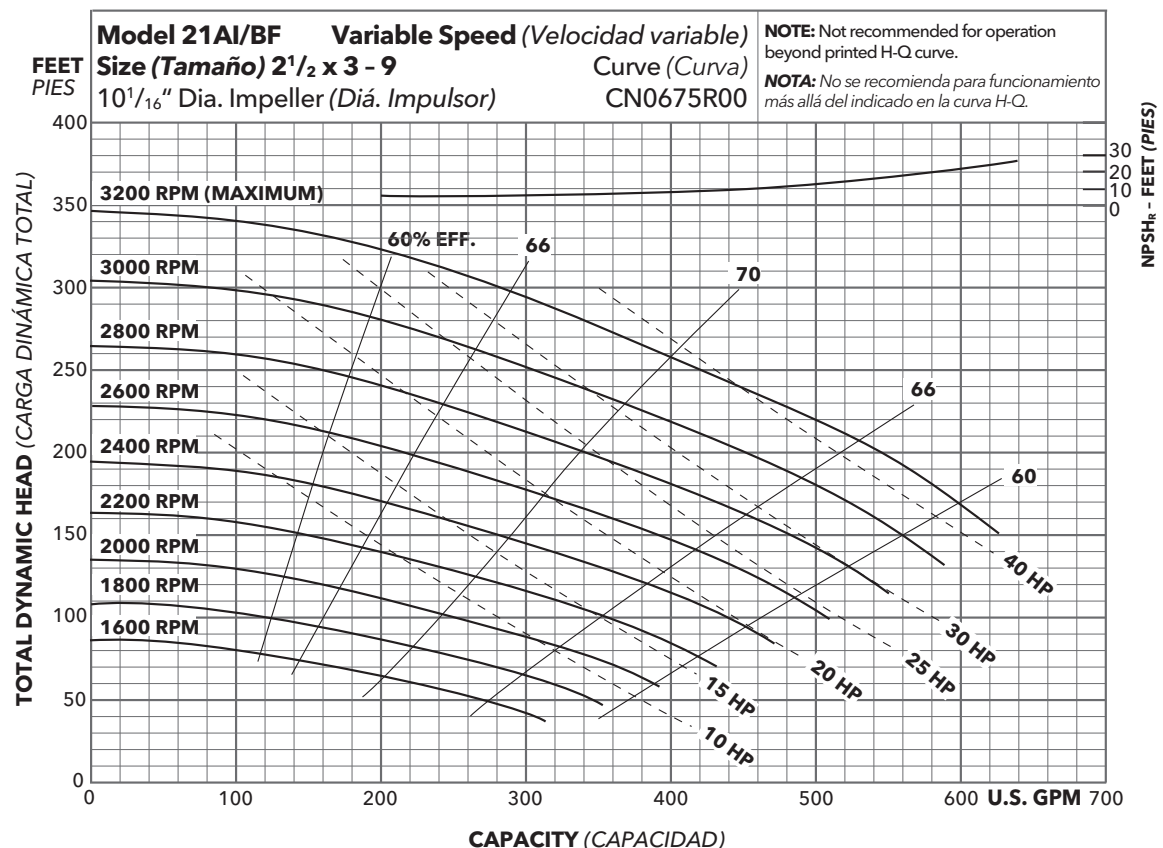
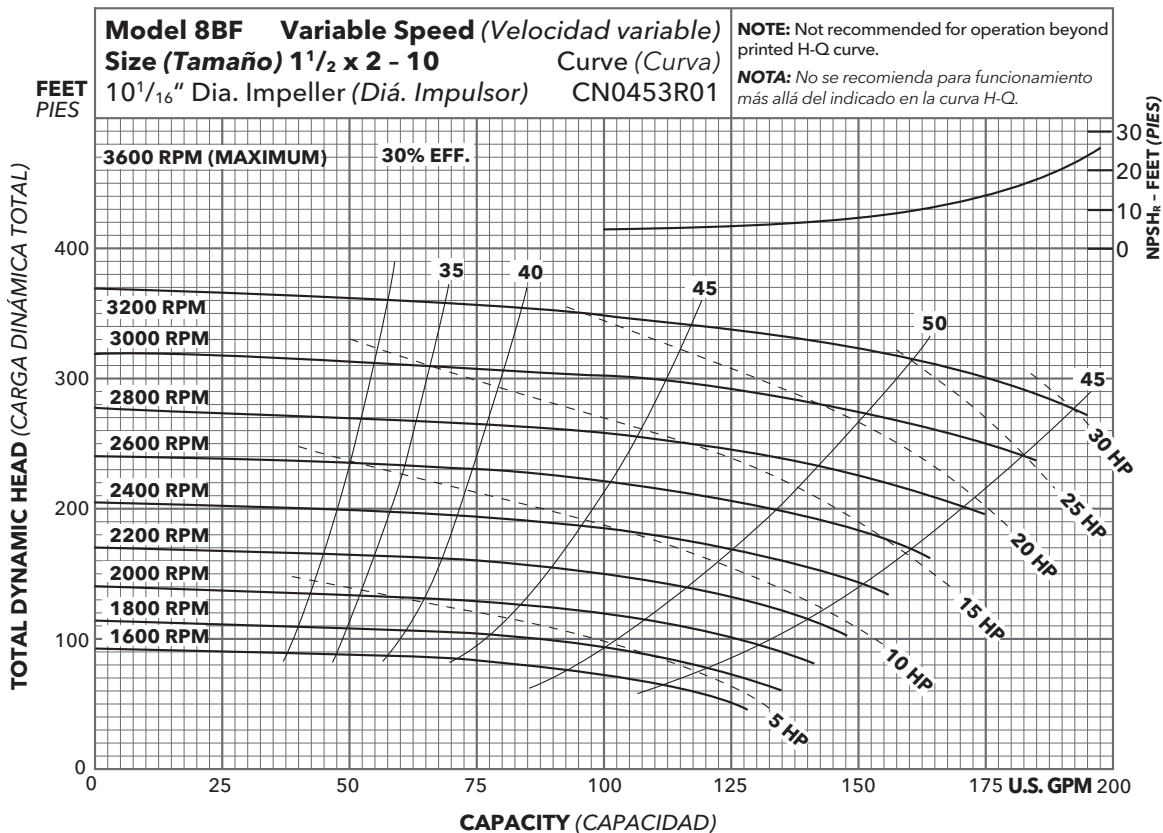

PERFORMANCE CURVES - VARIABLE SPEED CURVAS DE DESEMPEÑO - VELOCIDAD VARIABLE

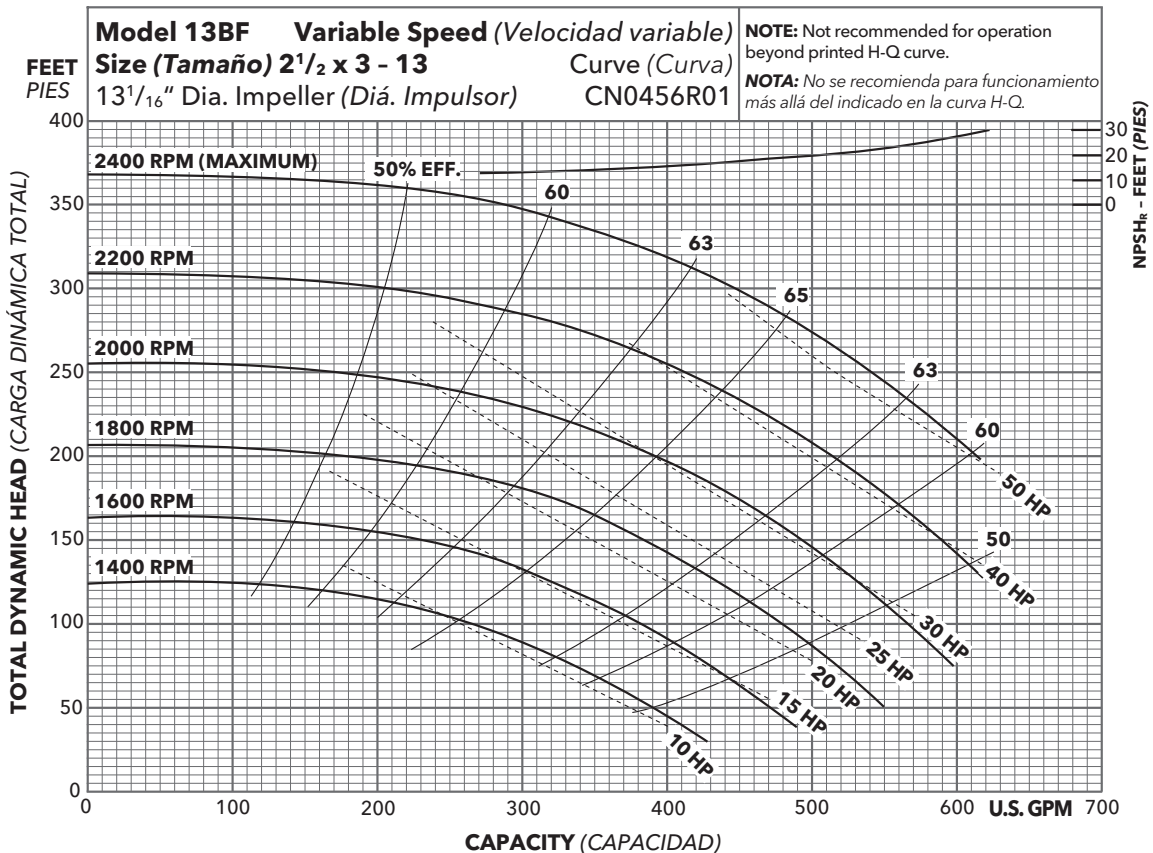
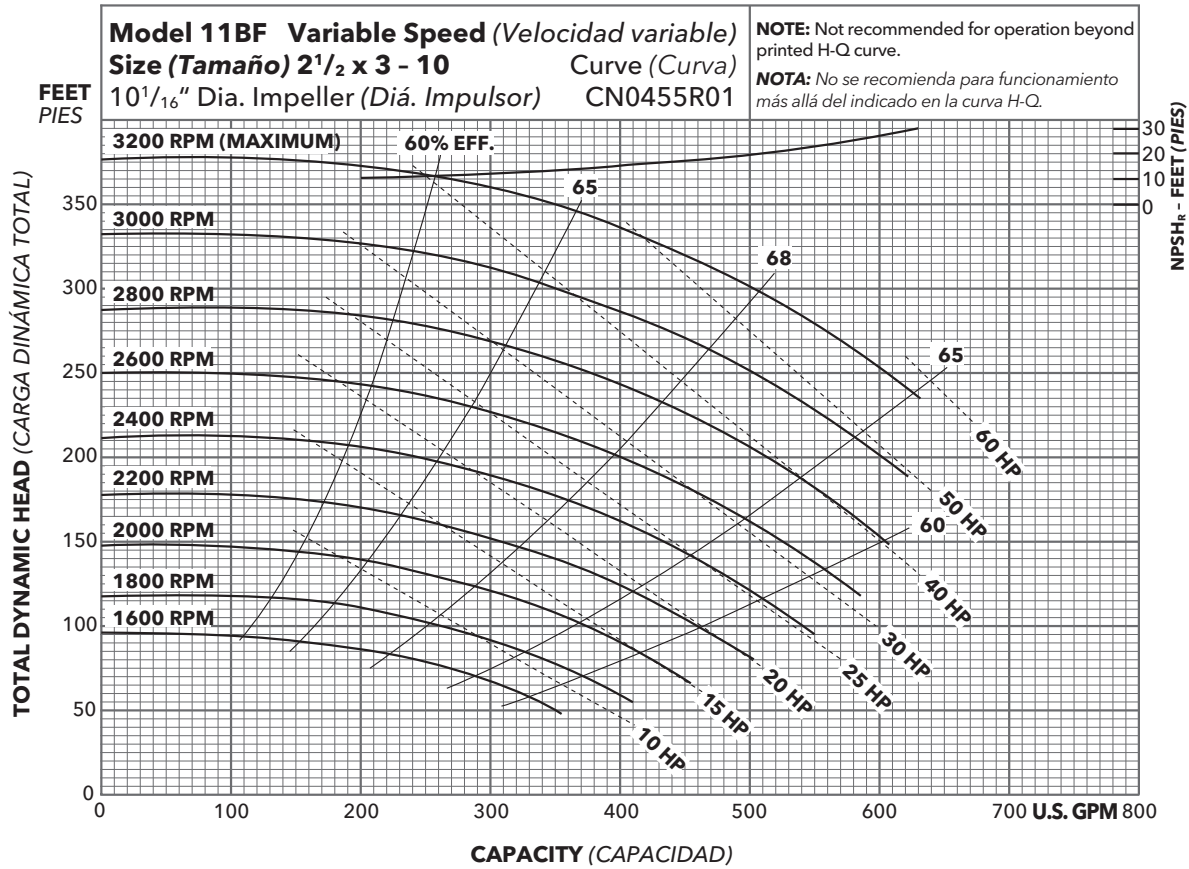

PERFORMANCE CURVES - VARIABLE SPEED CURVAS DE DESEMPEÑO - VELOCIDAD VARIABLE

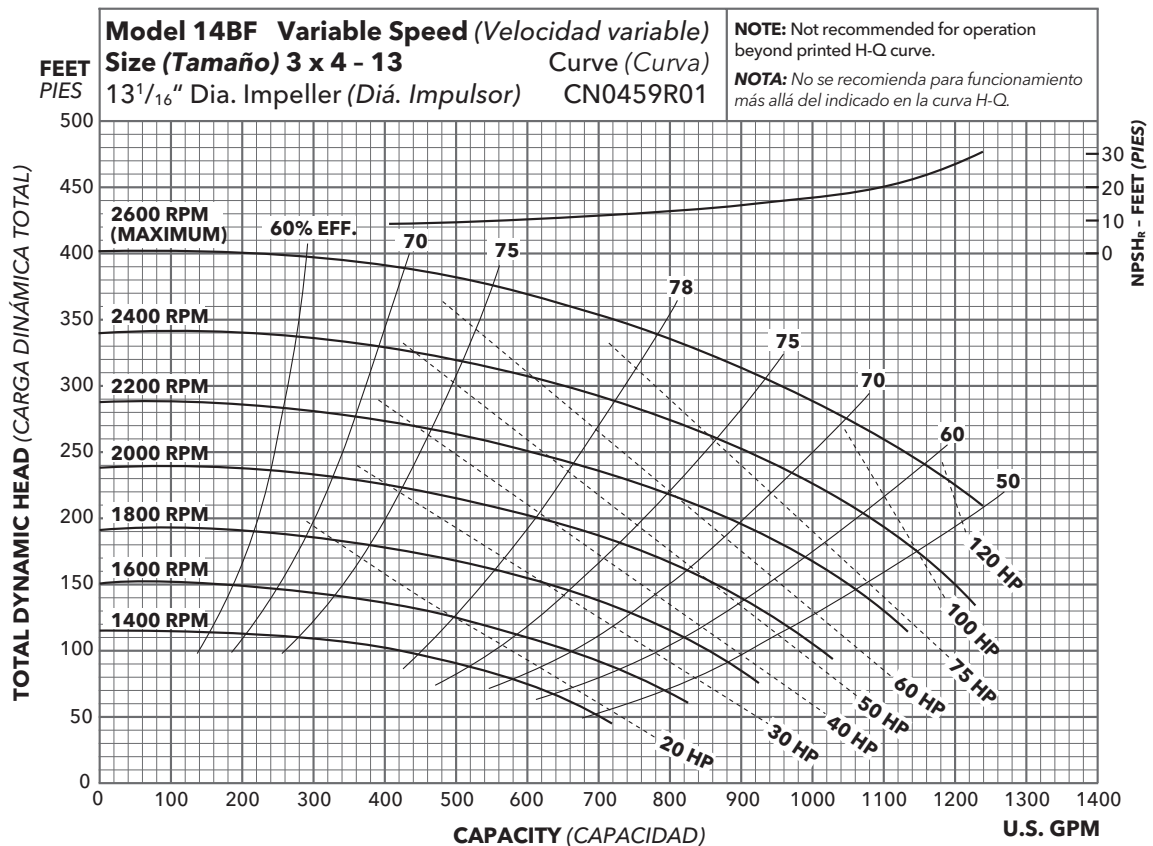
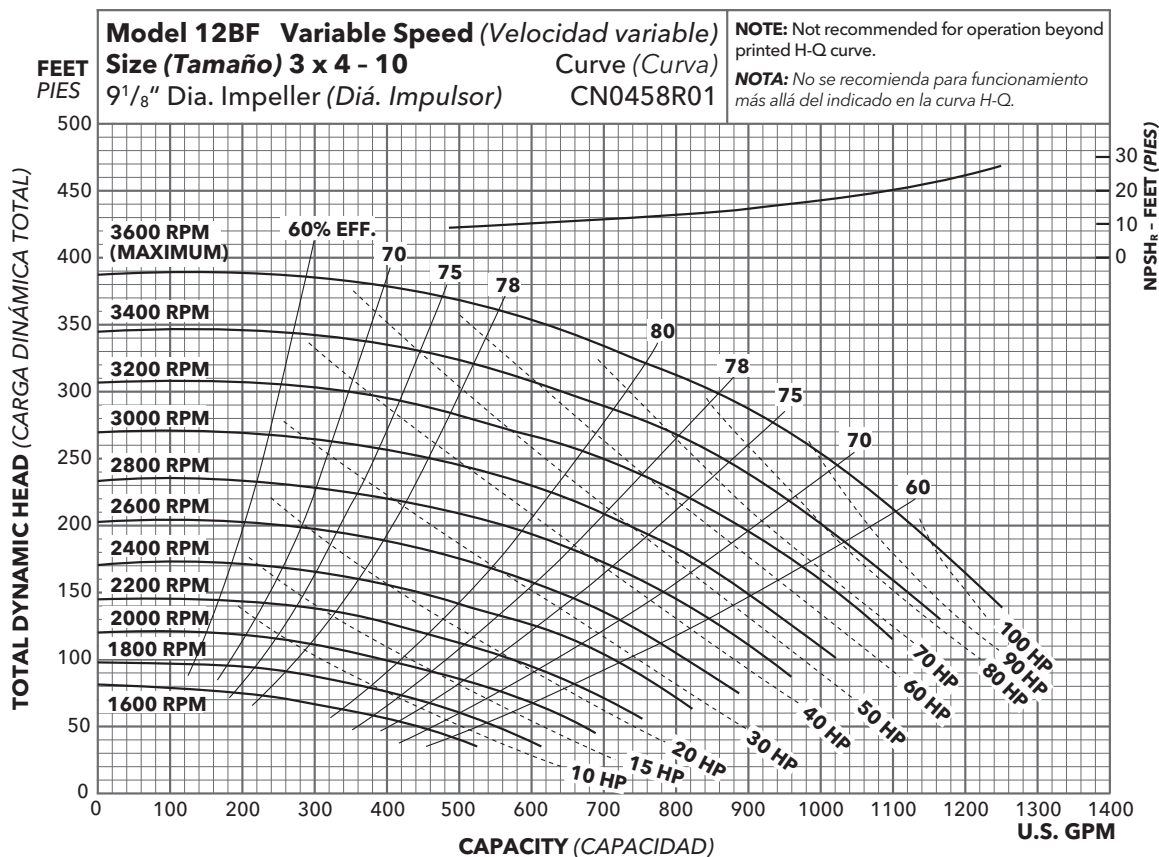

PERFORMANCE CURVES - VARIABLE SPEED CURVAS DE DESEMPEÑO - VELOCIDAD VARIABLE

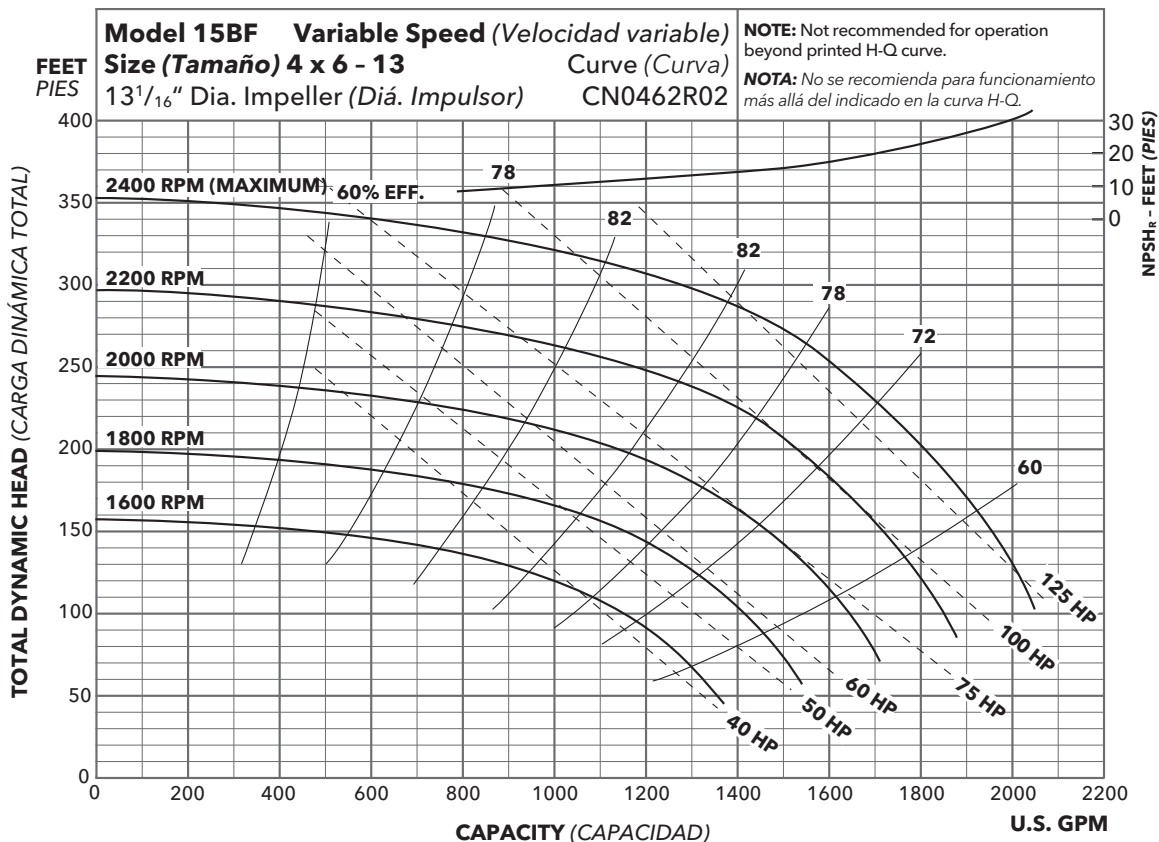
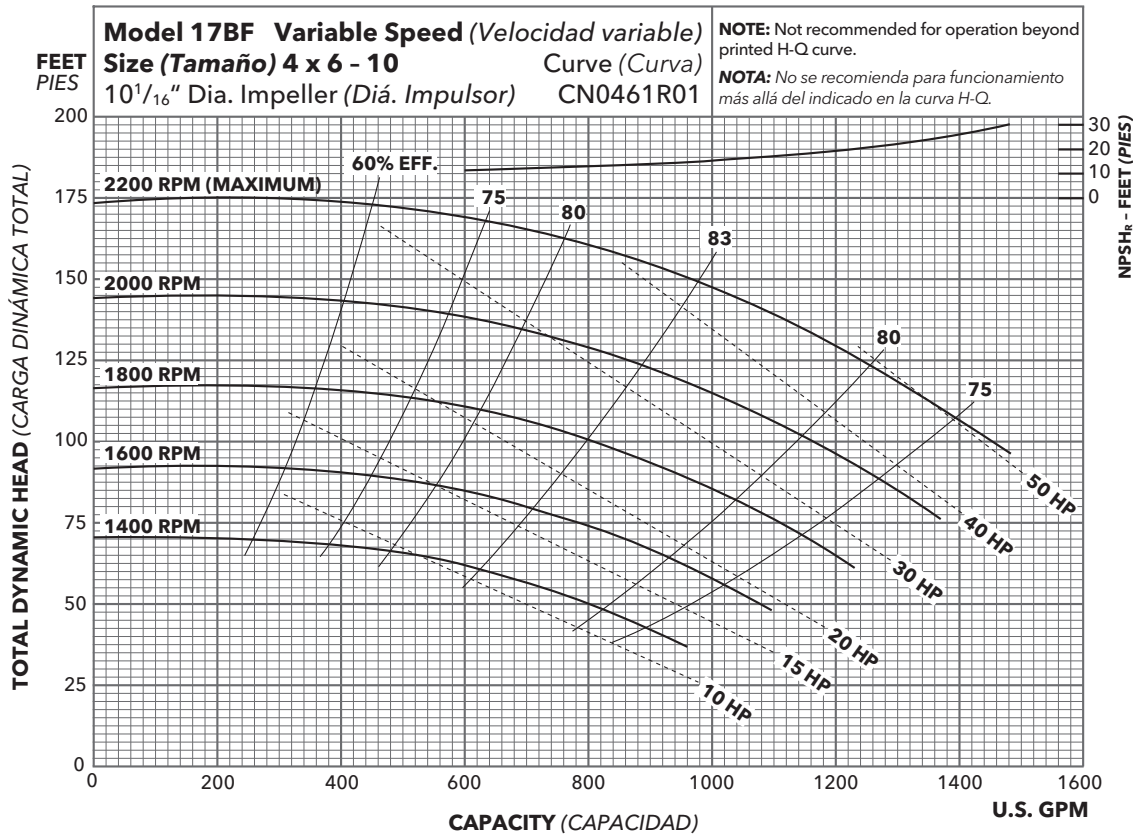

Commercial Water

PERFORMANCE CURVES - VARIABLE SPEED CURVAS DE DESEMPEÑO - VELOCIDAD VARIABLE

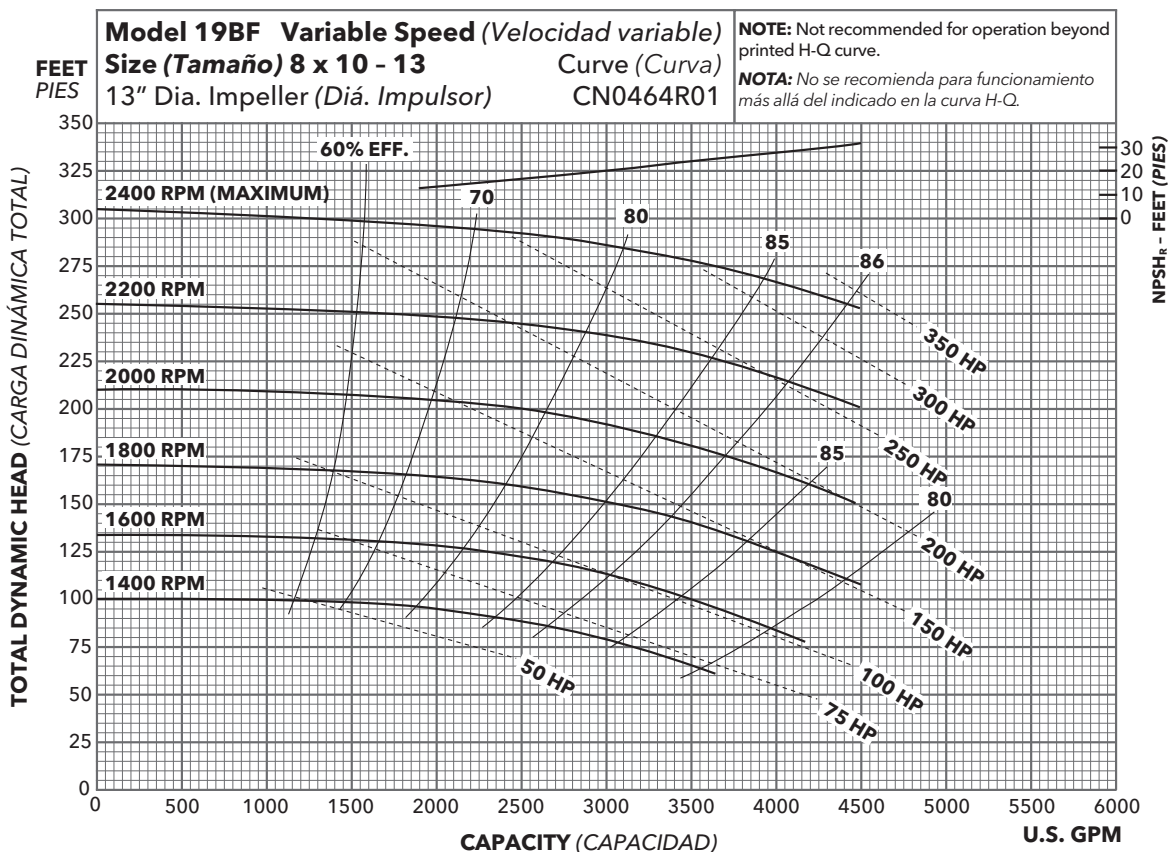
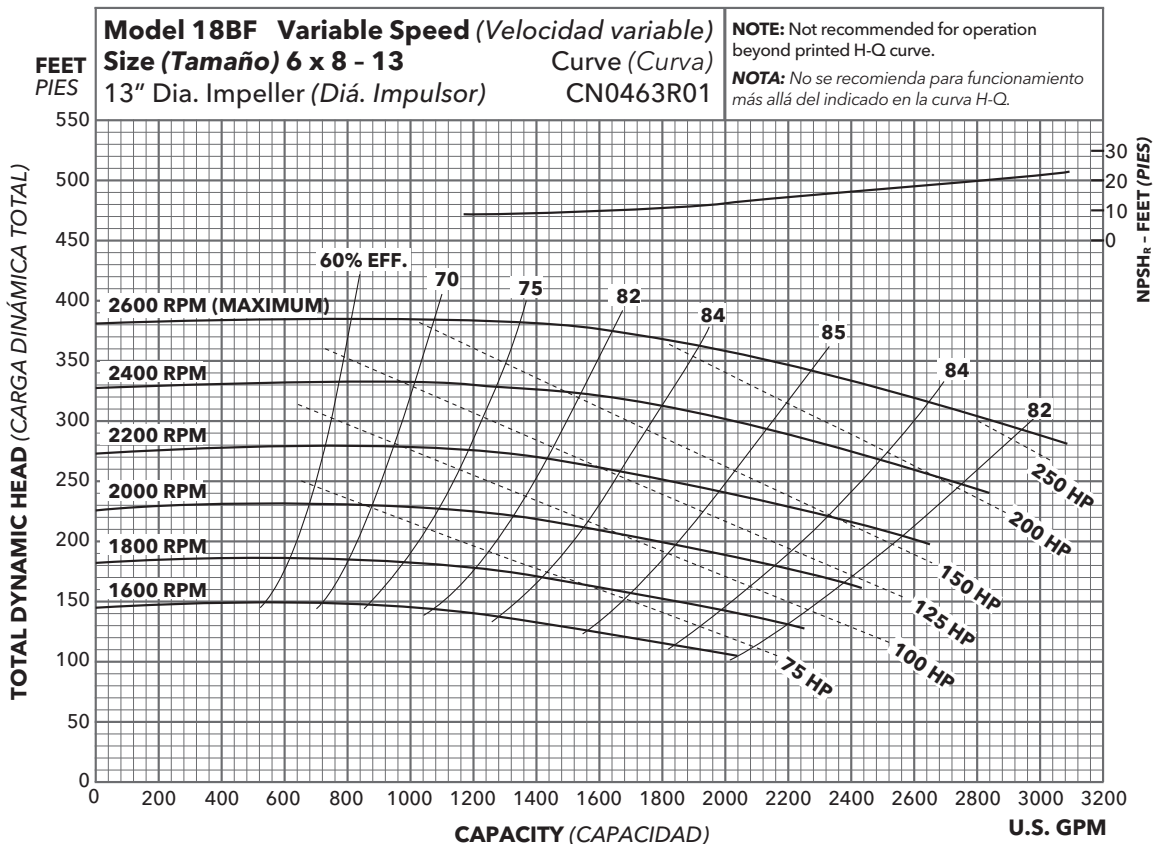

PERFORMANCE CURVES - VARIABLE SPEED CURVAS DE DESEMPEÑO - VELOCIDAD VARIABLE

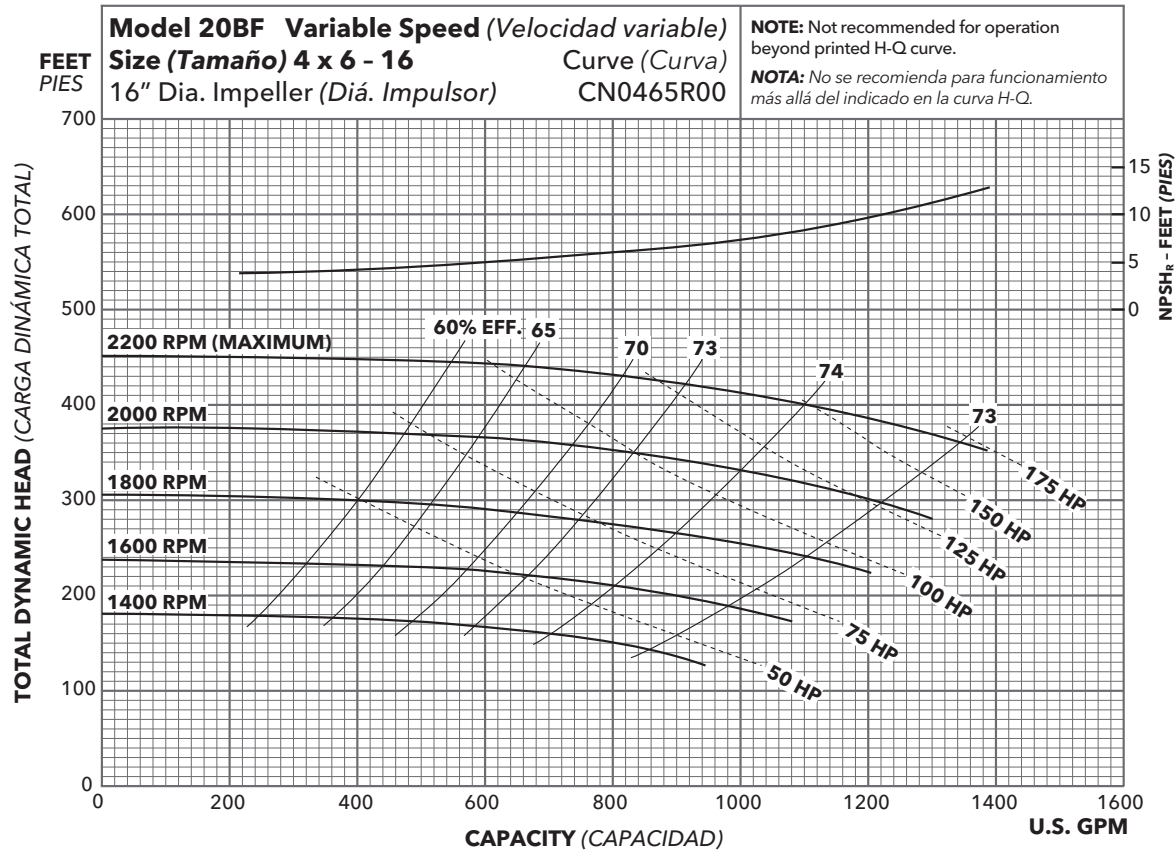

3656 M & L-GROUP MATERIALS OF CONSTRUCTION MATERIALES DE CONSTRUCCIÓN - GRUPO M Y L, MODELO 3656

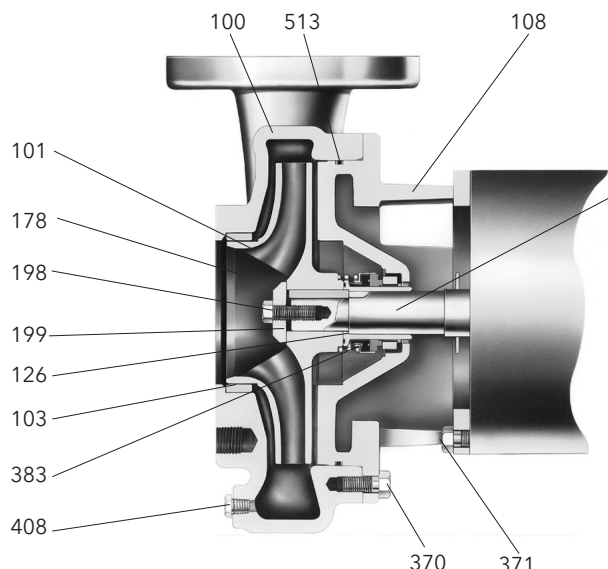

ANSI 1045 steel motor shaft extension (typical)

ANSI 1045 extensión del eje del motor de acero (típica)

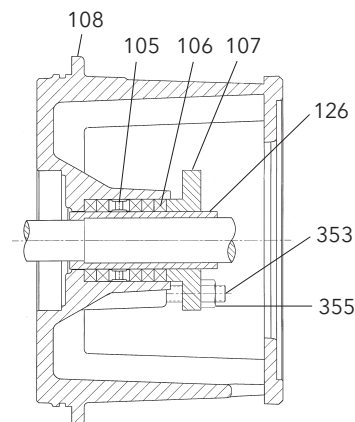

Packed Box Arrangement
Caja prensaestopas

Item No. No. ítem	Description Descripción	Materials, Materiales	
		All Iron Todo hierro	Bronze Fitted Accesorios de bronce
100	Casing, Carcasa		1003
101	Impeller, Impulsor		1101
103	Casing wear ring, Anillo de desgaste de la carcasa	1001	1618
108	Adapter/seal housing, Adaptador/Cubierta del sello		1001
126	Shaft sleeve, Camisa del eje		
178	Impeller key, Chaveta del impulsor	AISI Type 300 Series SS Acero inoxidable serie AISI tipo 300	
198	Impeller bolt, Tornillo del impulsor		
199	Impeller washer, Arandela del impulsor		
370	Hex head cap screw (adapter to case), Tornillo de cabeza hexagonal (del adaptador a la cubierta)		Steel Zinc Plated Grade 5 Acero SAE 1200 grado 5
371	Hex head cap screw (adapter to motor), Tornillo de cabeza hexagonal (del adaptador al motor)		
383	Mechanical seal, Sello mecánico	See seal chart, Ver tabla del sello	
408	Pipe plug 1/4" or 3/8", Tapón de tubos de 1/4 de pulgada ó 3/8 de pulgada		Zinc Plated Steel Zinc Plated Steel
513	O-ring, Anillo en O	BUNA-N - Standard, EPR - Optional Viton - Optional	

Material Code Código de material	Engineering Standard Norma de ingeniería
1003	Cast iron ASTM A48 CL30 Hierro fundido ASTM A48 CL20
1618	Bismuth Bronze - Lead Free, Bismuth Bronze - Lead Free
1001	Cast iron ASTM A48 CL20 Hierro fundido ASTM A48 CL20
1101	ASTM B584, Modified C87500 - Lead Free ASTM B584, modified C87500 - Lead Free

Packed Box Arrangement, Caja prensaestopas

Item No. No. ítem	Description Descripción	Materials Materiales
105	Lantern ring Aro de linterna	Teflon*
106	Packing, 5 rings Empaquetadura, 5 aros	Teflon Impregnated Impregnado de Teflon
107	Gland, Casquillo	AISI 316SS
126	Shaft sleeve Camisa del eje	
353	Gland stud Perno del casquillo	AISI Type 300 Series Stainless Steel Acero inoxidable serie AISI tipo 300
355	Gland nut Tuerca del casquillo	

NOTE:

Seal housing wear ring (item number 203) not shown. See repair parts page for detail. (Required for all models except 3 x 4 - 10.)

NOTA:

El anillo de desgaste del compartimiento de sello (ítem número 203) no se muestra. Consulte la página de piezas de repuesto para mayor detalle. (Se requiere para todos los modelos con excepción del 3 x 4 - 10).

Mechanical Seal Chart, Type 21, Tabla para sello mecánico, tipo 21

Item No., No. ítem	Part No., Pieza Número			Rotary, Rotativo	Stationary, Estacionario	Elastomers, Elastómeros	Metal Parts, Partes Metálicas	Intended Duty, Servicio previsto
	M-Group, Grupo-M		L-Group, Grupo-L					
	180JM-210JM 180JP-210CZ*	250JM-360TCZ 210JP-360TCZ* M Bearing Frame, Bastidor de cojinetes M	All motors, Todos los motores L Bearing Frame, Bastidor de cojinetes L					
383	10K13	10K16	10K84	Carbon, Carbone	Ceramic, Cerámica	BUNA-N	316 SS, 316 Acero inoxidable	Standard, Estándar
	10K19	10K20	Consult Factory, Consultar con la fábrica					High Temp, Caustic, Alta temp/Caustic
	10K27	10K45	10K112	Sil-Carbide Carburo de silicona	Viton	Abrasive, Abrasivo		
	10K64	10K65	10K144					
	15K17	15K3	15K4			Packed Box Design with BUNA O-Ring, Diseño de prensaestopas empacado con anillo en O de BUNA		

* All Packed Box units use JP style motors. Todas las unidades de prensaestopas empacado utilizan motores estilo JP.

3756 M & L-GROUP MATERIALS OF CONSTRUCTION MATERIALES DE CONSTRUCCIÓN - GRUPO M Y L, MODELO 3756

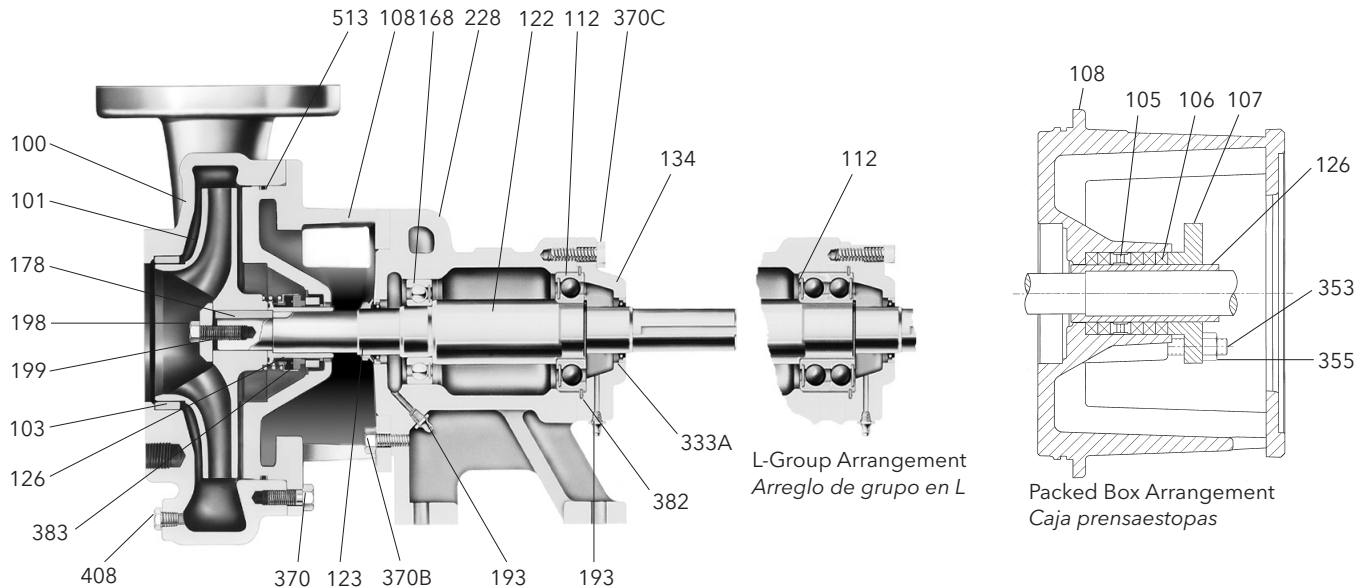

Item No. No. ítem	Description Descripción	Materials, Materiales	
		All Iron Todo hierro	Bronze Fitted Accesorios de bronce
100	Casing, Carcasa		1003
101	Impeller, Impulsor		1101
103	Casing wear ring, Anillo de desgaste de la carcasa		1618
108	Adapter/seal housing, Adaptador/Cubierta del sello	1001	1001
126	Shaft sleeve, Camisa del eje		
178	Impeller key, Chaveta del impulsor	AISI Type 300 Series SS	
198	Impeller bolt, Tornillo del impulsor	Acero inoxidable serie AISI tipo 300	
199	Impeller washer, Arandela del impulsor		
370	Hex head cap screw (adapter to case), Tornillo de cabeza hexagonal (del adaptador a la cubierta)		Steel Zinc Plated Grade 5
370B	Hex head cap screw (adapter to bearing frame), Tornillo de cabeza hexagonal (del adaptador al motor)		Acero Zinc Plated grado 5
383	Mechanical seal, Sello mecánico	See seal chart, Ver tabla del sello	
408	Pipe plug 1/4" or 3/8", Tapón de tubos de 1/4 de pulgada ó 3/8 de pulgada		Zinc Plated Steel, Zinc Plated Acero
513	O-ring, Anillo en O	BUNA-N - Standard, Standard EPR - Optional, Optional Viton - Optional, Optional	

Power End Components, Componentes del extremo de fuerza

228	Bearing frame, Marco de cojinete	Cast iron ASTM A48 CL20
134	Bearing cover, Cubierta del cojinete	Hierro fundido ASTM A48 CL20

Item No. No. ítem	Description Descripción	Materials, Materiales	
		All Iron Todo hierro	Bronze Fitted Accesorios de bronce
122	Pump shaft, Eje de la bomba		Steel, Acero
168	Ball bearing (inboard), Cojinete de bolas (interior)		Steel, Acero
112	Ball bearing (outboard), Cojinete de bolas (exterior)		Steel, Acero
382	Retaining ring, bearing, Anillo de retención, cojinete		Steel Zinc Plated Grade 5, Acero Zinc Plated grado 5
370C	Hex head cap screw (bearing frame to cover), Tornillo de cabeza hexagonal (de la cubierta de cojinetes al marco)		Steel Zinc Plated grade 5
333A	Lip seal, Sello con reborde		BUNA-N
193	Grease fitting, Accesorio grasa		Steel, Acero
123	V-ring deflector, Anillo en V (Deflector)		BUNA-N

Packed Box Arrangement, Caja prensaestopas

Item No. No. ítem	Description Descripción	Materials Materiales
105	Lantern ring Aro de linterna	Teflon*
106	Packing, 5 rings Empaquetadura, 5 aros	Teflon Impregnated Impregnado de Teflon
107	Gland, Casquillo	AISI 316SS
126	Shaft sleeve Camisa del eje	
353	Gland stud Perno del casquillo	AISI Type 300 Series Stainless Steel Acero inoxidable serie AISI tipo 300
355	Gland nut Tuerca del casquillo	

Material Code Código de material	Engineering Standard Norma de ingeniería
1001	Cast iron ASTM A48 CL20 Hierro fundido ASTM A48 CL20
1102	Sil-Brass ASTM B584, Modified C87500 - Lead Free Sil-Brass ASTM B584, Modified C87500 - Lead Free
1003	Cast Iron ASTM A48 CL30 Cast Iron ASTM A48 CL30
1618	Bismuth Bronze - Lead Free Bismuth Bronze - Lead Free

3756 M & L-GROUP SAE DRIVE MATERIALS OF CONSTRUCTION MATERIALES DE CONSTRUCCIÓN - GRUPO M Y L, MODELO 3756

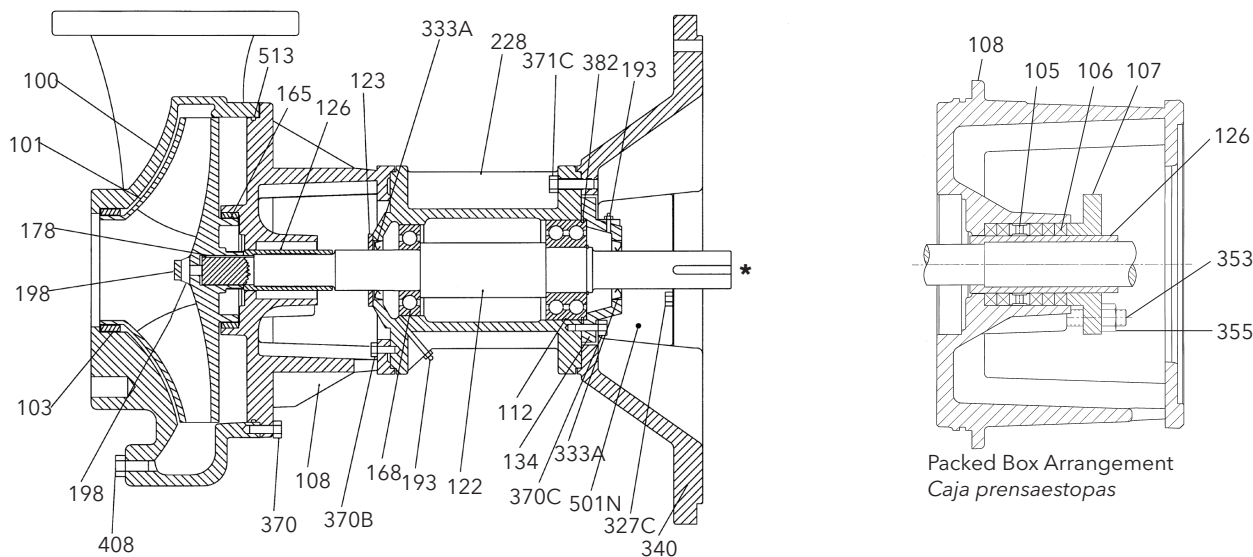

* **Note:** There is an SAE splined shaft option, see page 41 and price book.

* **Nota:** Hay una opción ranurada SAE del eje, ve la paginación 41 y el libro del precio.

Item No. No. Ítem	Description Descripción	Materials, Materiales	
		All Iron Todo hierro	Bronze Fitted Accesorios de bronce
100	Casing, Carcasa		1003
101	Impeller, Impulsor		1101
103	Casing wear ring, Anillo de desgaste de la carcasa		1618
108	Adapter/seal housing, Adaptador/Cubierta del sello	1001	1001
126	Shaft sleeve, Camisa del eje	AISI Type 300 Series SS	
178	Impeller key, Chaveta del impulsor	Acero inoxidable serie	
198	Impeller nut, Tornillo del impulsor	AISI tipo 300	
370	Hex head cap screw (adapter to case), Tornillo de cabeza hexagonal (del adaptador a la cubierta)	Steel Zinc Plated Grade 5	
370B	Hex head cap screw (adapter to bearing frame), Tornillo de cabeza hexagonal (del adaptador al motor)	Acero Zinc Plated grado 5	
383	Mechanical seal, Sello mecánico	See seal chart, Ver tabla del sello	
408	Pipe plug 1/4" or 3/8", Tapón de tubos de 1/4 de pulgada ó 3/8 de pulgada	Zinc Plated Steel, Zinc Plated Acero	
513	O-ring, Anillo en O	BUNA-N - Standard, Standard EPR - Optional, Optional Viton - Optional, Optional	
Power End Components, Componentes del extremo de fuerza			
228	Bearing frame, Marco de cojinete		1003
134	Bearing cover, Cubierta del cojinete		1001
340	Adapter/Engine, Adaptador/Motor		1003
371C	Hex head cap screw (adapter to bearing frame)	Steel SAE 1200 grade 5	
501N	Cover/adapter, Cubierta/Adaptador	Galvanized steel	
327C	Cap screw (cover to adapter)	Steel SAE 1200 grade 5	

Item No. No. Ítem	Description Descripción	Materials, Materiales	
		All Iron Todo hierro	Bronze Fitted Accesorios de bronce
122	Pump shaft, Eje de la bomba		AISI 4140
168	Ball bearing (inboard), Cojinete de bolas (interior)	Steel, Acero	
112	Ball bearing (outboard), Cojinete de bolas (exterior)		Steel, Acero
382	Retaining ring, bearing, Anillo de retención, cojinete		Steel SAE 1200 Grade 5, Acero SAE 1200 grado 5
370C	Hex head cap screw (bearing frame to cover), Tornillo de cabeza hexagonal (de la cubierta de cojinetes al marco)		Acero SAE 1200 grado 5
333A	Lip seal, Sello con reborde		BUNA-N
193	Grease fitting, Accesorio grasa	Steel, Acero	
123	V-ring deflector, Anillo en V (Deflector)		BUNA-N

Packed Box Arrangement, Caja prensaestopas

Item No. No. ítem	Description Descripción	Materials Materiales
105	Lantern ring Aro de linterna	Teflon*
106	Packing, 5 rings Empaquetadura, 5 aros	Teflon Impregnated Impregnado de Teflon
107	Gland, Casquillo	AISI 316SS
126	Shaft sleeve Camisa del eje	
353	Gland stud Perno del casquillo	AISI Type 300 Series Stainless Steel Acero inoxidable serie AISI tipo 300
355	Gland nut Tuerca del casquillo	

Material Code Código de material	Engineering Standard Norma de ingeniería
1001	Cast iron ASTM A48 CL20 Hierro fundido ASTM A48 CL20
1003	Cast iron ASTM A48 CL30 Hierro fundido ASTM A48 CL30
1101	Sil-Brass ASTM B584, Modified C87500 - Lead Free Sil-Brass ASTM B584, Modified C87500 - Lead Free
1618	Bismuth Bronze - Lead Free, Bismuth Bronze - Lead Free

3656 M & L-Group Dimensions and Weights Grupo M y L, modelo 3656 - Peso y dimensiones

Mechanical Seal Sello mecánico

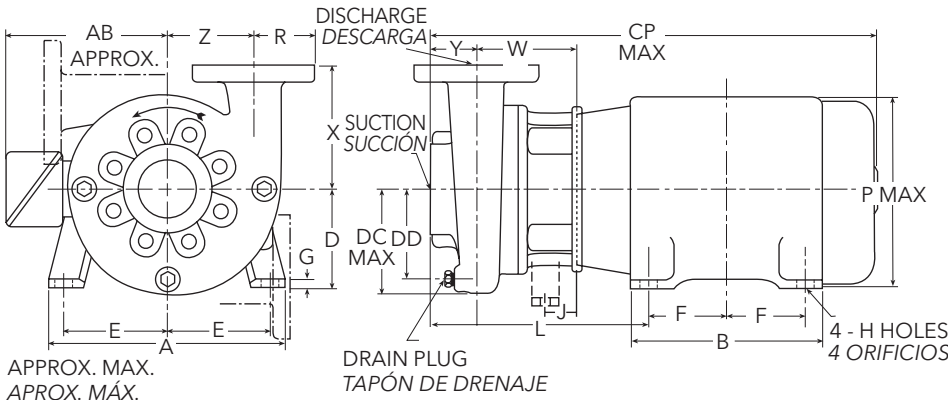

NOTE:

1. All pumps shipped in vertical discharge position. For other orientations, remove casing bolts, rotate to desired position, and tighten 3/8" - 16 casing bolts to 37 ft./lbs. torque., 1/2" - 13 casing bolts to 90 ft./lbs. torque.
2. Dimensions in inches, weight in pounds.
3. Not to be used for construction purposes.

NOTA:

1. Todas las bombas se embarcan con la descarga en posición vertical. Para otras orientaciones, retire los pernos de la carcasa, haga rotar la descarga hasta la posición deseada y ajuste los 16 pernos de 3/8 de pulgada a una torsión de 37 pies/libra, y los 13 pernos de 1/2 pulgada a 90 pies/libra.
2. Dimensiones en pulgadas, peso en libras.
3. No utilizar con fines de construcción.

Pump Dimensions and Weights (Dimension "L" determined by Pump and Motor), **Peso y dimensiones de la bomba** (la dimension "L" esta determinada por la bomba y el motor)

Pump Bomba	Suction Succión	Discharge Descarga	CP Max.	DC Max.	DD	R	NPT Drain Drenaje NPT	W	X	Y	Z	Weight (lbs) Pesos (libras)	L					
													Motor Frame, Bastidor del motor					
													140	180	210	250/280	320	360
1 1/2 x 2 - 10	2*	1 1/2*	30 3/4	6 3/4	5 7/8	1 1/4	1 1/4	5	6	3	5 1/2	93	10 7/8	11 1/2	12 1/2	12 3/4	-	-
2 1/2 x 3 - 8	3*	2 1/2*	30 3/4	6 1/4	5 1/4	1 13/16	1 1/4	5 1/8	6	3 3/8	5	78	11 3/8	12	13	13 1/4	-	-
2 1/2 x 3 - 9	3	2 1/2	33 1/2	7 7/8	6	3 1/2	3/8	5	7 1/2	2 3/4	5 1/2	85	10 5/8	11 1/4	12 1/4	12 1/2	13	13 5/8
2 1/2 x 3 - 10			30 1/4	8 7/8	7 3/8													
2 1/2 x 3 - 13	4	3	30 1/16	6 1/4	5 3/8	3 3/4	1/4	5 5/16	7	3	5 5/8	82	11 1/16	11 13/16	12 13/16	13 1/16	13 5/8	-
3 x 4 - 8			30 3/8	7 3/8	6 1/2			5 1/8	7 1/2		5 1/2	99	11	11 5/8	12 7/8	12 7/8	-	-
3 x 4 - 10			33 1/4	9 1/2	8 7/8			5	9		7 1/2	155	-	-	12 1/2	12 3/4	-	-
3 x 4 - 13	5	4	34 1/4	6 7/8	5 3/4	4 1/2	3/8	5 1/2	8	3	5	99	11 3/8	12	13	13 1/4	13 3/4	14 3/8
4 x 5 - 8			30 7/8	8 5/8	7 1/2			5 1/2	8 1/2		3 3/8	7	135	-	-	13 3/8	13 3/8	-
4 x 6 - 10	6	4	32	9 3/4	8 7/8	4 1/2	3/8	5 1/4	9	3	7 1/2	171	-	-	12 1/2	12 3/4	13	-
4 x 6 - 13			5 1/4	9	3			7 1/2	171		-	-	12 1/2	12 3/4	13	-		
6 x 8 - 13	See Packed Box Dimension Page. (pumps utilize JP motors), Ver la página de dimensiones de la caja empacada. (JP motors)																	
8 x 10 - 13																		
4 x 6 - 16																		

*Denotes NPT connection. All other connections are for use with ANSI class 150 mating flanges.

Dimensions in inches, weights in lbs. Do not use for construction purposes.

*Indica conexión NPT Las demás conexiones deben usarse con bridas de contacto ANSI clase 150.

Dimensiones en pulgadas, peso en libras. No utilizar para fines de construcción.

Motor Dimensions and Weights (may vary with manufacturer)*

Pesos y dimensiones del motor (pueden variar de acuerdo al fabricante)*

Motor Frame Bastidor del motor	A	AB (Max.)	B	D	E	F	G	H	P* (Max.)	Weight (lbs.) Pesos (libras)
143JM	6 1/2	5 1/4	6	3 1/2	2 3/4	2	1/8	5/16	6 5/8	41
145JM										57
182JM	8 1/2	5 7/8	6 1/2	4 1/2	3 3/4	2 1/4	3/16	3/8	7 7/8	77
184JM										97
213JM	9 1/2	7 3/8	8	5 1/4	4 1/4	2 3/4	1/4	1/2	9 5/8	122
215JM										155
213TCZ										122
215TCZ										155
254JM	11 1/4	9	9 1/2	6 1/4	5	4 1/8	1/4	1/2	11 1/2	265
256JM										320
284JM	12 1/4	12 1/4	10 3/4	7	5 1/2	4 3/4	1/4	1/2	13 1/4	419
286JM										422
324JM	13 1/4	13 1/4	12	8	6 1/4	5 1/4	5/16	5/8	15 1/8	562
326JM										588
364TCZ	17 1/2	15 1/8	14 1/2	9	7	5 3/8	1	5/8	18 3/8	775
365TCZ										1005

Motor Frames and Horsepower Bastidores del motor y potencia en HP

Frame Size JM Tamaño del bastidor JM	ODP	TEFC	RPM
143 JM	1	1	1750
145 JM	1 1/2, 2	1 1/2, 2	
182 JM	3	3	
184 JM	5	5	
213 JM	7 1/2	7 1/2	
215 JM, 215 TCZ	10	10	
254 JM	15	15	
256 JM	20	20	
284 JM	25	25	
324 JM	40	40	
326 JM	50	50	3500
143 JM	1 1/2	1 1/2	
145 JM	2, 3	2	
182 JM	5	3	
184 JM	7 1/2	5	
213 JM	10	7 1/2	
215 JM	15	10	
215 TCZ	15	-	
254 JM	20	15	
256 JM	25	20	
284 JM	30	25	
286 JM	40	30	
324 JM	50	40	
326 JM	60	50	
364 TCZ	75	60	
365 TCZ	-	75	

3656 M & L-GROUP DIMENSIONS AND WEIGHTS GRUPO M Y L, MODELO 3656 - PESO Y DIMENSIONES

PACKED BOX CAJA PRENSAETOPAS

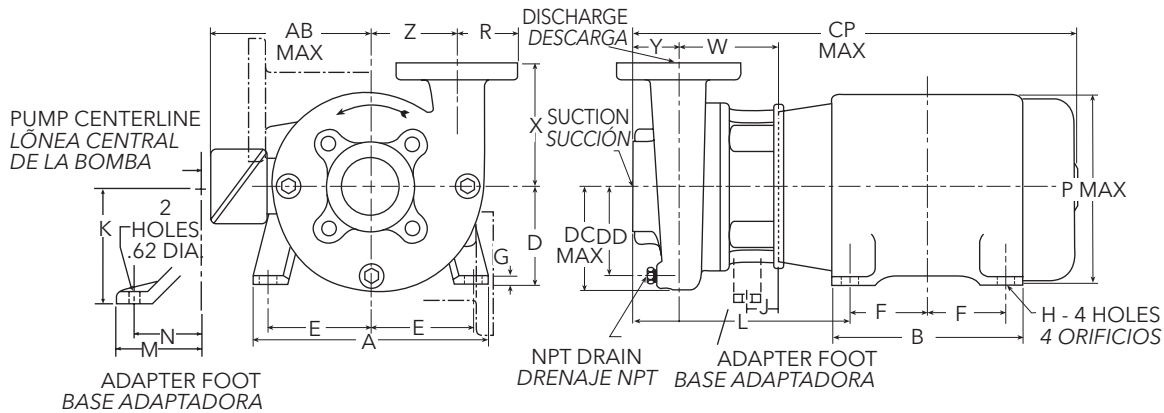

Pump Dimensions and Weights, Peso y dimensiones de la bomba

Pump Bomba	Suction Succión	Discharge Descarga	CP Max.	DC Max.	DD	J	K	M	N	R	NPT Drain Drenaje NPT	W	X	Y	Z	Wt. (lbs.) Pesos (libras)	Motor Frame, Bastidor del motor L													
																	210	250/280	320	360	400	440								
1½ x 2 - 10	2*	1½*	3¼	6¾	5⅞	-	-	-	-	1¼	¼	7⅞	6	3	5½	105	16⅞	12¾	-	-	-	-								
2½ x 3 - 8	3*	2½*	3¼	6¼	5¼	-	-	-	-	1⅜	¼	8	-	3⅞	5	90	16⅞	13¼	-	-	-	-								
2½ x 3 - 9	3	2½	37⅞	7⅞	6	-	-	-	-	3½	⅜	7⅞	7½	2¾	5½	95	16⅞	12½	15⅞	16½	-	-								
2½ x 3 - 10			34⅞	8⅞	7⅞	-	-	-	-	3													7½	155	16⅞	12¾	-	-	-	-
2½ x 3 - 13	4	3	34⅞	8⅞	7⅞	-	-	-	-	3¾	¼	8¾	7	3	7½	155	16⅞	12¾	-	-	-	-								
3 x 4 - 8			34⅞	6¼	5⅞	-	-	-	-	5⅞													90	16⅞	13¼	16½	-	-	-	-
3 x 4 - 10			34⅞	7⅞	6½	-	-	-	-	5½													110	16⅞	12⅞	-	-	-	-	-
3 x 4 - 13			37⅞	9½	8⅞	-	-	-	-	7½													170	16⅞	12¾	-	-	-	-	-
4 x 5 - 8	5	4	38⅞	6⅞	5¾	-	-	-	-	4½	⅜	8⅞	8	5	110	16⅞	13¼	16⅞	17¼	-	-	-								
4 x 6 - 10			34¾	8⅞	7½	-	-	-	-	7													145	17	13⅞	-	-	-	-	
4 x 6 - 13	6	4	35⅞	9¾	8⅞	-	-	-	-	4½	⅜	8⅞	8½	3⅞	7	185	16⅞	12¾	16⅞	-	-	-								
n 4 x 6 - 16			47⅞	12¾	11	1⅜	9¾	8	7	10½													390	16⅞	17¼	17⅞	18⅞	19¼	-	
n 6 x 8 - 13	8	6	45⅞	12¾	10½	2⅞	7½	6½	5½	5½	8⅞	11	3⅞	8¾	290	16¾	17¼	17¾	18⅞	18⅞	19¾	19¾								
n 8 x 10 - 13			48⅞	14¾	13	2⅞	7½	6½	5½	6¾													520	17⅞	17⅞	18⅞	18¾	19¼	20⅞	

*Denotes NPT connection. All other connections are for use with ANSI class 150 mating flanges. * Indica conexión NPT Las demás conexiones deben usarse con bridas de contacto ANSI clase 150. n Indicates "L" Group pump (dimensions valid for packed box or mechanical seal). n Indica una bomba Grupo "L" (dimensiones válidas para caja empacada o sella mecánico).

Motor Dimensions and Weights (may vary with manufacturer)*, Peso y dimensiones del motor (pueden variar de acuerdo al fabricante) *

Motor Frame Bastidor del motor	A	AB Max.	B	D	E	F	G	H	P Max.	Horsepower								Wt. Max.
										3500 RPM				1750 RPM				
										1 Phase		3 Phase		1 Phase		3 Phase		
										ODP	TEFC	ODP	TEFC	ODP	TEFC	ODP	TEFC	
213JP	9½	7⅞	8	5¼	4¼	2¾	¼	1⅜	9⅞	7½	-	10	-	5	-	7½	7½	125
3½						10				-	15	10&15	7½&10	-	10	10	155	
254JP	11¼	9	11¾	6¼	5	4⅞	¼	1⅞	11½	-	-	20	-	-	-	15	15	255
5						-				-	25	20	-	-	20	20	280	
284JP	12¼	12¼	12¼	7	5½	4¾	¼	1⅞	13¼	-	-	30	25	-	-	25	25	410
5½						-				-	40	30	-	-	30	30	425	
324JP	13¼	13¼	13½	8	6¼	5¼	⅝	2⅜	15⅞	-	-	50	40	-	-	40	40	560
6						-				-	60	50	-	-	50	50	590	
364TCZ	17½	14⅞	15⅞	9	7	5⅞	1	2⅜	18⅞	-	-	75	60 & 75	-	-	60	60	775
6⅞						-				-	-	-	-	75	75	1005		
404TCZ	19½	17½	16⅞	10	8	6⅞	1	1⅜	20⅞	-	-	-	-	-	-	100	100	1110
6⅞						-				-	-	-	-	125	-	1163		
444TCZ	21½	19⅞	19½	11	9	7¼	1	1⅜	22½	-	-	-	-	-	-	150	125	1600
8¼						-				-	-	-	-	150	150	1708		

NOTE:

- All pumps shipped in vertical discharge position. For other orientations, remove casing bolts, rotate to desired position, and tighten ⅜ - 16 casing bolts to 37 ft./lbs. torque., ½ - 13 casing bolts to 90 ft./lbs. torque.
- Dimensions in inches, weight in pounds.
- Not to be used for construction purposes.

NOTA:

- Todas las bombas se embarcan con la descarga en posición vertical. Para otras orientaciones, retire los pernos de la carcasa, haga rotar la descarga hasta la posición deseada y ajuste los 16 pernos de ⅜ de pulgada a una torsión de 37 pies/libra, y los 13 pernos de ½ pulgada a 90 pies/libra.
- Dimensiones en pulgadas, peso en libras.
- No utilizar con fines de construcción.

3756 M & L-GROUP DIMENSIONS AND WEIGHTS GRUPO M Y L, MODELO 3756 - PESO Y DIMENSIONES

MECHANICAL SEAL SELLO MECÁNICO

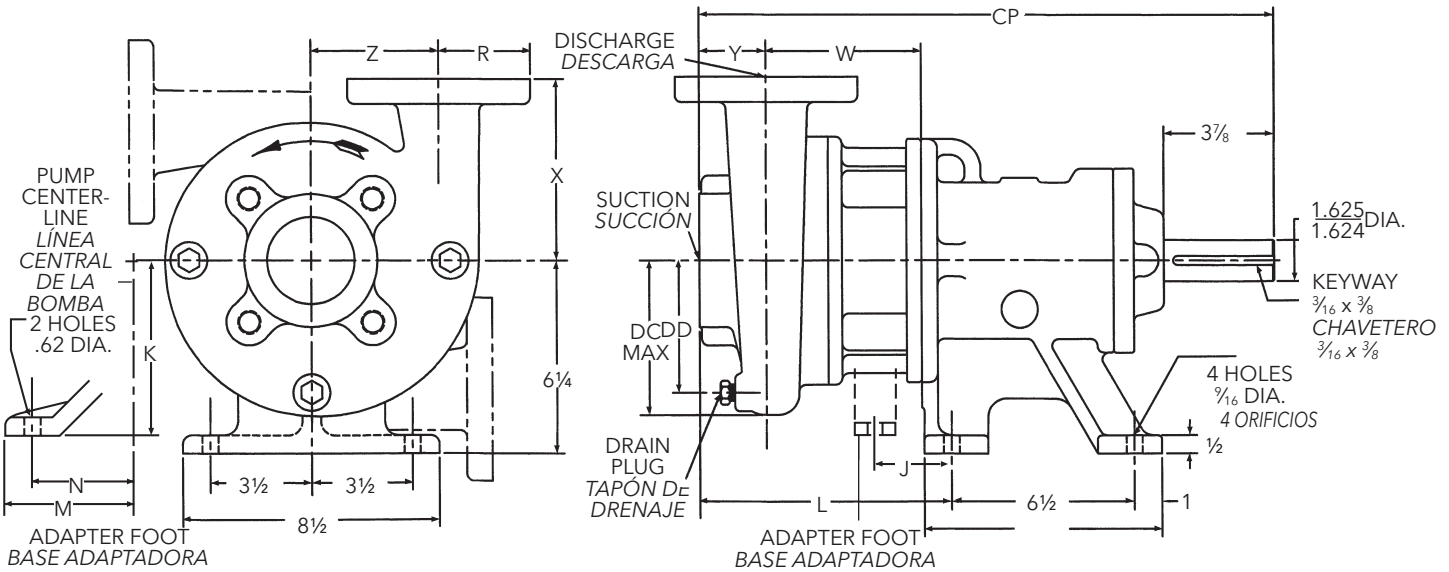

Motor Dimensions and Weights (may vary with manufacturer)*

Pesos y dimensiones del motor (pueden variar de acuerdo al fabricante)*

Pump Bomba	Suction Succión	Discharge Descarga	CP	DC (Max.)	DD	L	J	K	M	N	R	NPT Drain Drenaje NPT	W	X	Y	Z	Weight (lbs.) Pesos (libras)
1 1/2 x 2 -10	2*	1 1/2*	21 7/8	6 3/4	5 7/8	9 3/8	-	-	-	-	1 1/4	1/4	5	6	3	5 1/2	155
2 1/2 x 3 - 8	3*	2 1/2*	22 3/8	6 1/4	5 1/4	9 7/8	-	-	-	-	1 13/16	1/4	5 7/8	6	3 3/8	5	140
2 1/2 x 3 - 9	3	2 1/2	21 7/8	7 1/8	6	9 1/8	-	-	-	-	3 1/2	3/8	5	7 1/2	2 3/4	5 1/2	147
2 1/2 x 3 - 10			21 7/8	8 7/8	7 5/8	9 3/8	-	-	-	-	3 1/2		5	9	3	7 1/2	201
2 1/2 x 3 - 13	4	3	22 3/16	6 1/4	5 3/8	9 11/16	-	-	-	-	3 3/4	1/4	5 5/16	7	3	5 5/8	144
3 x 4 - 8			22	7 3/8	6 1/2	9 1/2	-	-	-	-	3 3/4		5 1/8	7 1/2		5 1/2	161
3 x 4 - 10			21 7/8	9 1/2	8 1/8	9 3/8	-	-	-	-	3 3/4		5	9		7 1/2	217
3 x 4 - 13	5	4	22 3/8	6 7/8	5 3/4	9 7/8	-	-	-	-	4 1/2	3/8	5 1/2	8	5	161	
4 x 5 - 8			22 1/2	8 7/8	7 1/2	10	-	-	-	-	4 1/2		5 1/2	8 1/2	3 3/8	7	200
4 x 6 - 10	6	4	22 1/8	9 3/4	8 1/8	9 5/8	-	-	-	-	4 1/2	3/8	5 1/4	9	3	7 1/2	233
4 x 6 - 13			26 1/2	12 3/4	11	12 13/16	2 9/16	9 3/4	8	7	5 1/2		8 5/8	12	4	10 1/2	430
n 4 x 6 - 16	8	6	25 1/4	12 3/4	10 1/2	13 5/8	3 3/4	7 1/2	6 1/2	5 1/2	5 1/2	3/8	8 3/8	11	3 7/8	8 3/4	330
n 6 x 8 - 13			26 1/2	14 3/4	13	14	3 3/4	7 1/2	6 1/2	5 1/2	6 3/4		8 5/8	12 3/4	4	10	515
n 8 x 10 - 13	10	8	26 1/2	14 3/4	13	14	3 3/4	7 1/2	6 1/2	5 1/2	6 3/4	3/8	8 5/8	12 3/4	4	10	515

*Denotes NPT connection. All other connections are for use with ANSI class 150 mating flanges. Dimensions in inches, weights in lbs. Do not use for construction purposes.

* Indica conexión NPT Las demás conexiones deben usarse con bridas de contacto ANSI clase 150. Dimensiones en pulgadas, peso en libras. No utilizar para fines de construcción.

n Indicates "L" Group pump., n Indica una bomba Grupo "L".

NOTE:

1. All pumps shipped in vertical discharge position. For other orientations, remove casing bolts, rotate to desired position, and tighten 3/8" - 16 casing bolts to 37 ft./lbs. torque., 1/2" - 13 casing bolts to 90 ft./lbs. torque.
2. Dimensions in inches, weight in pounds.
3. Not to be used for construction purposes.

NOTA:

1. Todas las bombas se embarcan con la descarga en posición vertical. Para otras orientaciones, retire los pernos de la carcasa, haga rotar la descarga hasta la posición deseada y ajuste los 16 pernos de 3/8 de pulgada a una torsión de 37 pies/libra, y los 13 pernos de 1/2 pulgada a 90 pies/libra.
2. Dimensiones en pulgadas, peso en libras.
3. No utilizar con fines de construcción.

3756 M & L-GROUP DIMENSIONS AND WEIGHTS GRUPO M Y L, MODELO 3756 - PESO Y DIMENSIONES

PACKED BOX CAJA PRENSAETOPAS

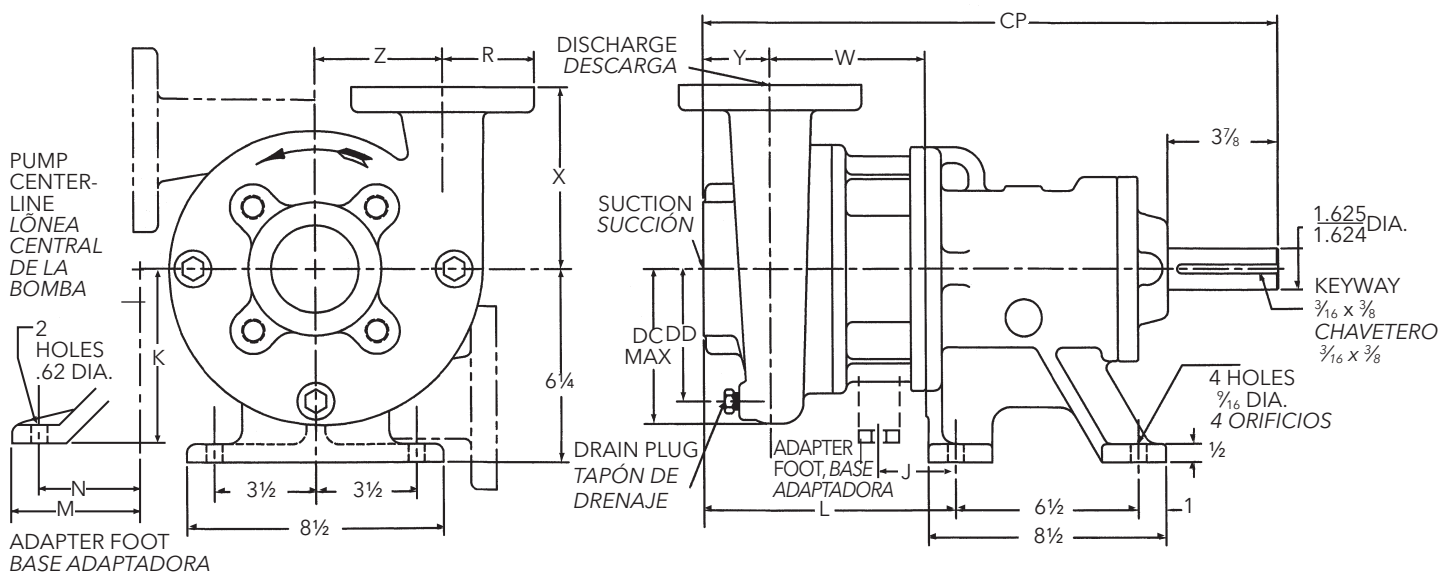

Motor Dimensions and Weights (may vary with manufacturer)*

Pesos y dimensiones del motor (pueden variar de acuerdo al fabricante)*

Pump Bomba	Suction Succión	Discharge Descarga	CP	DC (Max.)	DD	L	J	K	M	N	R	NPT Drain Drenaje NPT	W	X	Y	Z	Weight (lbs.) Pesos (libras)
1 1/2 x 2 - 10	2*	1 1/2*	24 3/4	6 3/4	5 7/8	12 1/4	-	-	-	-	1 1/4	7/8	7/8	3	5 1/2	165	
2 1/2 x 3 - 8	3*	2 1/2*	25 1/4	6 1/4	5 1/4	12 3/4	-	-	-	-	1 13/16	1/4	8	6	3 3/8	5	150
2 1/2 x 3 - 9	3	2 1/2	24 1/2	7 1/8	6	12	-	-	-	-	3 1/2	3/8	7 7/8	7 1/2	2 3/4	5 1/2	160
2 1/2 x 3 - 10			24 3/4	8 7/8	7 5/8	12 1/4	-	-	-	-	3 1/2		9	3	7 1/2	215	
2 1/2 x 3 - 13	4	3	22 1/16	6 1/4	5 3/8	12 5/16	-	-	-	-	3 3/4	1/4	8 3/16	7	3	5 5/8	155
3 x 4 - 8			24 7/8	7 3/8	6 1/2	12 3/8	-	-	-	-	3 3/4		8	7 1/2	3	5 1/2	170
3 x 4 - 10			24 3/4	9 1/2	8 1/8	12 1/4	-	-	-	-	3 3/4		7 7/8	9	3	7 1/2	230
3 x 4 - 13			24 3/4	9 1/2	8 1/8	12 1/4	-	-	-	-	3 3/4		8 3/8	8	3	5	170
4 x 5 - 8	5	4	25 1/4	6 7/8	5 3/4	12 3/4	-	-	-	-	4 1/2	3/8	8 3/8	8 1/2	3 3/8	7	210
4 x 6 - 10			25 3/8	8 7/8	7 1/2	12 7/8	-	-	-	-	4 1/2		8 3/8	8 1/2	3 3/8	7	210
4 x 6 - 13			25	9 3/4	8 1/8	12 1/2	-	-	-	-	4 1/2		8 1/8	9	3	7 1/2	245
n 4 x 6 - 16	6	4	26 1/2	12 3/4	11	12 13/16	2 1/16	9 3/4	8	7	5 1/2	3/8	8 5/8	12	4	10 1/2	430
n 6 x 8 - 13			25 1/4	12 3/4	10 1/2	13 5/8	3 3/4	7 1/2	6 1/2	5 1/2	5 1/2		8 3/8	11	3 3/8	8 3/4	330
n 8 x 10 - 13	10	8	26 1/2	14 3/4	13	14	3 3/4	7 1/2	6 1/2	5 1/2	6 3/4	3/8	8 5/8	12 3/4	4	10	515

n Indicates "L" Group pump., n Indica una bomba Grupo "L".

NOTE:

- All pumps shipped in vertical discharge position. For other orientations, remove casing bolts, rotate to desired position, and tighten 3/8 - 16 casing bolts to 37 ft./lbs. torque., 1/2 - 13 casing bolts to 90 ft./lbs. torque.
- Dimensions in inches, weight in pounds.
- Not to be used for construction purposes.

NOTA:

- Todas las bombas se embarcan con la descarga en posición vertical. Para otras orientaciones, retire los pernos de la carcasa, haga rotar la descarga hasta la posición deseada y ajuste los 16 pernos de 3/8 de pulgada a una torsión de 37 pies/libra, y los 13 pernos de 1/2 pulgada a 90 pies/libra.
- Dimensiones en pulgadas, peso en libras.
- No utilizar con fines de construcción.

ENGINEERING DATA - M-GROUP DATOS DE INGENIERÍA - GRUPO M

MECHANICAL SEAL SELLO MECÁNICO

Channel Steel Bedplate. Clockwise rotation viewed from drive end.

Placa de asiento de acero acanalado. Rotación dextrorsa (sentido de las agujas del reloj) cuando se mira desde el extremo del motor.

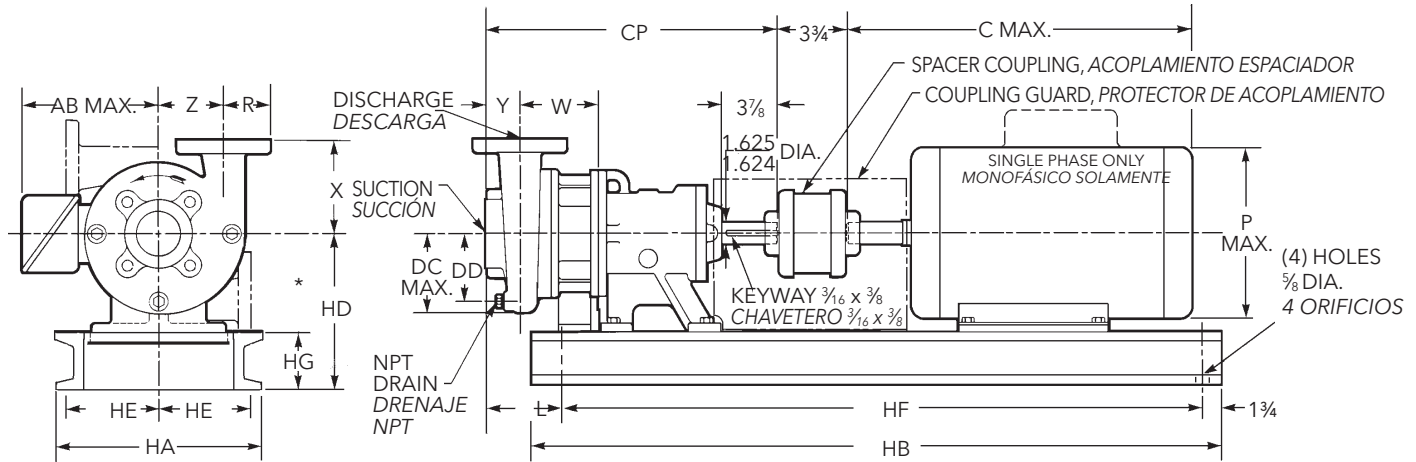

* Dimension will include any special shims required to match pump centerline to motor.
* La dimensión incluye cualquier cuña especial que se requiera para hacer coincidir la línea central de la bomba con el motor.

Pump Dimensions and Weights, Peso y dimensiones de la bomba

Pump Bomba	Suction Succión	Discharge Descarga	CP Max.	DC Max.	DD	L	R	NPT Drain Drenaje NPT	W	X	Y	Z	Weight (lbs) Pesos (libras)
1 1/2 x 2 -10	2*	1 1/2*	21 7/8	6 3/4	5 7/8	9 3/8	1 1/4	1 1/4	5	6	3	5 1/2	155
2 1/2 x 3 - 8	3*	2 1/2*	22 3/8	6 1/4	5 1/4	9 7/8	1 13/16		5 1/8				5
2 1/2 x 3 - 9	3	2 1/2	21 3/8	7 1/8	6	9 7/8	3 1/2	3/8	5	7 1/2	2 3/4	5 1/2	147
2 1/2 x 3 - 10			21 1/8	8 1/8	7 3/8	9 3/8							9
2 1/2 x 3 - 13	4	3	22 3/16	6 1/4	5 3/8	9 1/16	3 3/4	1/4	5 5/16	7	3	5 5/8	144
3 x 4 - 8			22	7 3/8	6 1/2	9 1/2			5 1/8	7 1/2		5 1/2	161
3 x 4 - 10			21 1/8	9 1/2	8 1/8	9 3/8			5	9		7 1/2	217
3 x 4 - 13	5	4	22 3/8	6 7/8	5 3/4	9 7/8	4 1/2	3/8	5 1/2	8	3	5	161
4 x 5 - 8			22 1/2	8 3/8	7 1/2	10			5 1/2	8 1/2		3 3/8	7
4 x 6 - 10	6	4	22 1/8	9 3/4	8 1/8	9 3/8	4 1/2	3/8	5 1/4	9	3	7 1/2	233
4 x 6 - 13			22 1/8	9 3/4	8 1/8	9 3/8			5 1/4	9		3	7 1/2

*Denotes NPT connection. All other connections are for use with ANSI class 150 mating flanges.
* Indica conexión NPT Las demás conexiones deben usarse con bridas de contacto ANSI clase 150.

Motor and Bedplate Dimensions and Weights (may vary with manufacturer.) Peso y dimensiones del motor y la placa de asiento (pueden variar de acuerdo al fabricante)

Motor Frame Bastidor del motor	HP @ 3500 RPM		HP @ 1750 RPM - T- Frame Only, Bastidor T únicamente		AB Max.	C Max.	P Max.	Wt. (lbs.) Pesos (libras)	Bedplate Data, Datos de la placa de asiento							Weight (lbs) Pesos (libras)	Motor Shim Cuña del motor	Bearing Frame Shim, Cuña del bastidor de cojinetes
	Three phase, Trifásico								HA	HB	HD	HE	HF	HG				
	ODP*	TEFC*	ODP*	TEFC*														
184T	-	-	5	5	5 7/8	18	8	95	13	42	10 1/4	5 1/4	38 1/2	4	111	1 3/4	-	
213T	-	-	7 1/2	7 1/2	7 3/8	18	9 3/8	116								1	-	
215T	15	-	10	10	7 3/8	19 7/8	13	136								-	-	
254T	20	15	15	15	10 1/8	21 1/8	15	266	15	44	10 1/2	5 3/4	40 1/2	3 1/2	124	-	-	
256T	25	20	20	20	10 1/8	23 3/8		264								422		
284TS/T	30	25	25	25	12 5/8	24 7/8	17 3/8	392	18	48	12	7 1/4	44 1/2	4	183	-	3/4	
286TS/T	40	30	30	30	12 5/8	26 5/8		422										
324TS/T	50	40	40	40	14 1/8	28 3/4	18 7/8	592	18	48	13	7 1/4	44 1/2	4	183	-	1 3/4	
326TS/T	60	50	50	50	14 1/8	30 1/4		634										
364TS/T	75	60	60	60	15 1/8	31 3/8	18 7/8	834	18	48	13	7 1/4	44 1/2	4	183	-	2 3/4	
356TS/T	100	75	75	75	15 1/8	32 3/8		1000										

* Premium efficiency where required by Department of Energy regulations.
* Eficacia superior donde se requiera por el Ministerio de regulaciones de la Energía.

NOTE:

- All pumps shipped in vertical discharge position. For other orientations, remove casing bolts, rotate to desired position, and tighten 3/8 - 16 casing bolts to 37 ft./lbs. torque., 1/2 - 13 casing bolts to 90 ft./lbs. torque.
- Dimensions in inches, weight in pounds.
- Not to be used for construction purposes.

NOTA:

- Todas las bombas se embarcan con la descarga en posición vertical. Para otras orientaciones, retire los pernos de la carcasa, haga rotar la descarga hasta la posición deseada y ajuste los 16 pernos de 3/8 de pulgada a una torsión de 37 pies/libra, y los 13 pernos de 1/2 pulgada a 90 pies/libra.
- Dimensiones en pulgadas, peso en libras.
- No utilizar con fines de construcción.

ENGINEERING DATA - M-GROUP DATOS DE INGENIERÍA - GRUPO M

PACKED BOX CAJA PRENSAESTOPAS

Channel Steel Bedplate. Clockwise rotation viewed from drive end.

Placa de asiento de acero acanalado. Rotación dextrorsa (sentido de las agujas del reloj) cuando se mira desde el extremo del motor.

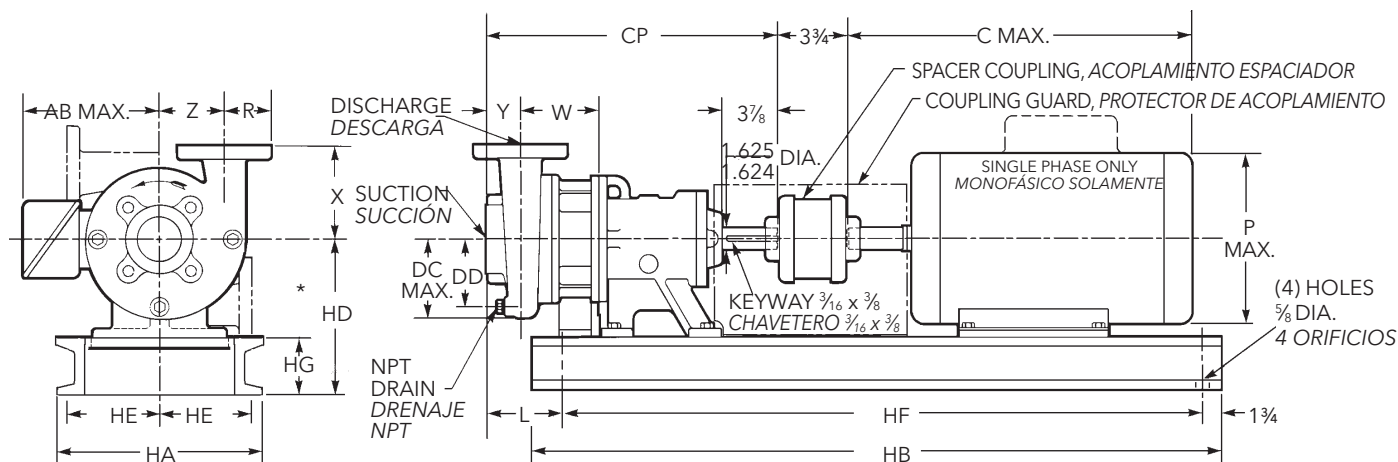

* Dimension will include any special shims required to match pump centerline to motor.

* La dimensión incluye cualquier cuña especial que se requiera para hacer coincidir la línea central de la bomba con el motor.

Pump Dimensions and Weights, *Peso y dimensiones de la bomba*

Pump Bomba	Suction Succión	Discharge Descarga	CP Max.	DC Max.	DD	L	R	NPT Drain Drenaje NPT	W	X	Y	Z	Weight (lbs) Pesos (libras)
1 1/2 x 2 - 10	2*	1 1/2*	2 3/4	6 3/8	5 7/8	12 1/4	1 1/4	1/4	7 7/8	6	3	5 1/2	165
2 1/2 x 3 - 8	3*	2 1/2*	2 5/4	6 1/4	5 1/4	12 3/4	1 13/16		8			3 3/8	5
2 1/2 x 3 - 9	3	2 1/2	2 1/2	7 1/8	6	12	3 1/2	3/8	7 7/8	7 1/2	2 3/4	5 1/2	160
2 1/2 x 3 - 10			2 3/4	8 7/8	7 5/8	12 1/4			9	3	7 1/2	215	
2 1/2 x 3 - 13	4	3	2 21/16	6 1/4	5 3/8	12 5/16	3 3/4	1/4	8 3/16	7	3	5 5/8	155
3 x 4 - 8			2 27/8	7 3/8	6 1/2	12 3/8			8	7 1/2		5 1/2	170
3 x 4 - 10			2 24 3/4	9 1/2	8 1/8	12 1/4			7 7/8	9		7 1/2	230
3 x 4 - 13	5	4	2 25 1/4	6 7/8	5 3/4	12 3/4	3/8	8 3/8	8	8 1/2	3 3/8	7	210
4 x 5 - 8			2 25 3/8	8 5/8	7 1/2	12 7/8			8 1/8		9	3	7 1/2
4 x 6 - 10	6	4	25	9 3/4	8 1/8	12 1/2	4 1/2	3/8	8 1/8	9	3	7 1/2	245
4 x 6 - 13			25	9 3/4	8 1/8	12 1/2			8 1/8	9	3	7 1/2	245

*Denotes NPT connection. All other connections are for use with ANSI class 150 mating flanges.

* Indica conexión NPT Las demás conexiones deben usarse con bridas de contacto ANSI clase 150.

NOTE:

- All pumps shipped in vertical discharge position. For other orientations, remove casing bolts, rotate to desired position, and tighten 3/8 - 16 casing bolts to 37 ft./lbs. torque., 1/2 - 13 casing bolts to 90 ft./lbs. torque.
- Dimensions in inches, weight in pounds.
- Not to be used for construction purposes.

NOTA:

- Todas las bombas se embarcan con la descarga en posición vertical. Para otras orientaciones, retire los pernos de la carcasa, haga rotar la descarga hasta la posición deseada y ajuste los 16 pernos de 3/8 de pulgada a una torsión de 37 pies/libra, y los 13 pernos de 1/2 pulgada a 90 pies/libra.
- Dimensiones en pulgadas, peso en libras.
- No utilizar con fines de construcción.

Motor and Bedplate Dimensions and Weights (may vary with manufacturer.)

Peso y dimensiones del motor y la placa de asiento (pueden variar de acuerdo al fabricante)

Motor Frame Bastidor del motor	HP @ 3500 RPM		HP @ 1750 RPM - T-Frame Only, Bastidor T únicamente		AB Max.	C Max.	P Max.	Wt. (lbs.) Pesos (libras)	Bedplate Data, Datos de la placa de asiento							Weight (lbs) Pesos (libras)	Motor Shim Cuña del motor	Bearing Frame Shim, Cuña del bastidor de cojinetes
	Three phase, Trifásico								HA	HB	HD	HE	HF	HG				
	ODP*	TEFC*	ODP*	TEFC*														
184T	-	-	5	5	5 7/8	18	8	95	13	42	10 1/4	5 1/4	38 1/2	4	111	1 3/4	-	
213T	-	-	7 1/2	7 1/2	7 3/8	18	9 5/8	116										
215T	15	-	10	10	7 3/8	19 1/8	13	136										
254T	20	15	15	15	10 1/8	21 3/8	13	266	15	44	10 1/2	5 3/4	40 1/2	3 1/2	124	-	3/4	
256T	25	20	20	20	10 1/8	23 3/8	13	264										
284TS/T	30	25	25	25	12 1/2	24 7/8	15	392	18	48	12	7 1/4	44 1/2	4	183	-	1 3/4	
286TS/T	40	30	30	30	12 1/2	26 5/8	15	422										
324TS/T	50	40	40	40	14 1/2	28 3/4	17 3/8	592	18	48	13	7 1/4	44 1/2	4	183	-	2 3/4	
326TS/T	60	50	50	50	14 1/2	30 1/4	17 3/8	634										
364TS/T	75	60	60	60	15 1/2	31 3/8	18 7/8	834	15 1/2	32 3/8	18 7/8	31 3/8	18 7/8	18 7/8	18 7/8	18 7/8	18 7/8	
356TS/T	100	75	75	75	15 1/2	32 3/8	18 7/8	1000										

* Premium efficiency where required by Department of Energy regulations.

* Eficacia superior donde se requiera por el Ministerio de regulaciones de la Energía.

ENGINEERING DATA - L-GROUP DATOS DE INGENIERÍA - GRUPO L

MECHANICAL SEAL & PACKED BOX SELLO MECÁNICO & CAJA PRENSAESTOPAS

Channel Steel Bedplate. Clockwise rotation viewed from drive end.

Placa de asiento de acero acanalado. Rotación dextrorsa (sentido de las agujas del reloj) cuando se mira desde el extremo del motor.

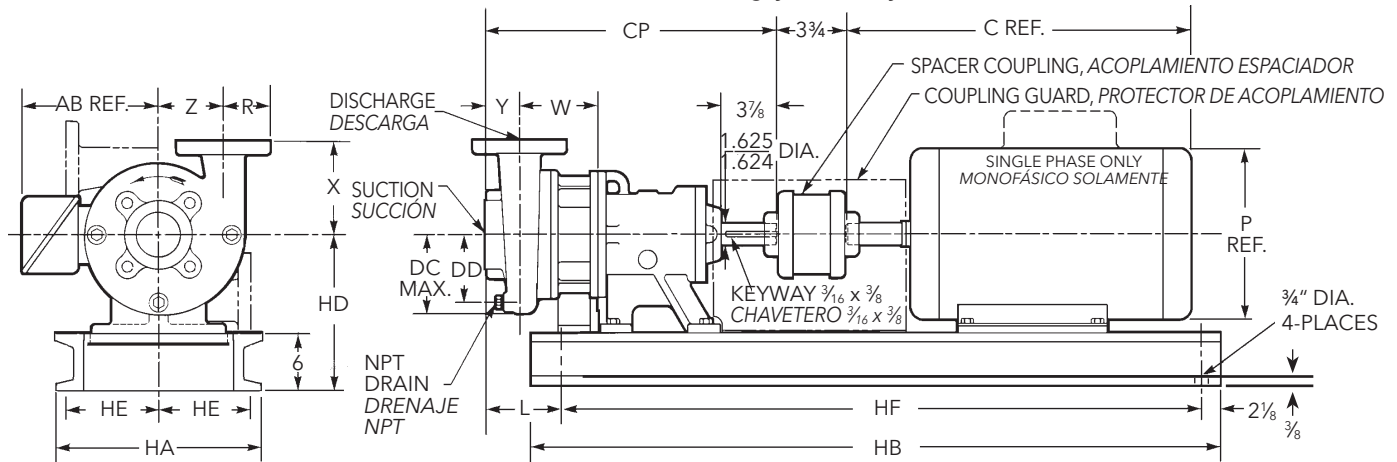

Dimensions and Weights, Pesos y dimensiones

Pump, Bomba	Size, Tamaño	Suction, Succión	Discharge, Descarga	CP	DC Max.	DD	L	R	W	X	Y	Z
18BF	6 x 8-13	8	6	25 1/4	12 3/4	10 1/2	13 5/8	5 1/2	8 3/8	11	3 3/8	8 3/4
19BF	8 x 10-13	10	8	26 1/2	14 3/4	13	14	6 3/4	8 3/8	12 3/4	4	10
20BF	4 x 6-16	6	4	26 1/2	12 3/4	11	12 13/16	4 1/2	8 3/8	12	4	10 1/2

Motor and Bedplate Dimensions and Weights, Peso y dimensiones del motor y la placa de asiento

Pump Size, Tamaño de Bomba	Motor Frame, Bastidor del motor	Motor Data							Baseplate Data								
		HP @ 3500 RPM		HP @ 1750 RPM		AB Ref.	C Ref.	P Ref.	Weight (lbs) Ref.		HA	HB	HD	HE	HF	Weight (lb), Pesos (libras)	Shim Height Under Motor, Altura de la Cuña Bajo el Motor
		Three Phase, Trifásica							Open	Encl.							
		ODP*	TEFC*	ODP*	TEFC*	+/- 1/4	+/- 1/4	+/- 1/8			+/- 1/16	+/- 1/16					
18BF	284T/286T			25,30	25,30	12.20	21.22	13.62	340	405	29.06	48	15.75	13.66	43.75	244	2"
	324T/326T			40,50	40,50	14.13	30	16.50	440	580							1"
	324TS/325TS	50,60	40,50				29		480	520							
	364T/365T			60,75	60,75	15.06	34	18.25	665	835							
	364TS/365TS	75,100	60,75				32		730	820							
	404TS/405TS	125,150	100			18	36	20.13	950	1150							
	404T/405T			100,125	100		39		930	1160							
	444TS/445TS	200-300	125,150			19.56	41	22.38	1250	1615							
	444T/445T			150-300	125-200		45		1370	1650							
	447TS	350	200				47		1800	2550							
449TS	400-450	250-400			21.69	51	23.75	1850	2550								
447T			350	250		48		1800	2260								
19BF	284T/286T			25,30	25,30	12.20	21.22	13.62	340	405	29.06	48	15.75	13.66	43.75	244	2"
	324T/326T			40,50	40,50	14.13	30	16.50	440	580							1"
	324TS/325TS	50,60	40,50				29		480	520							
	364T/365T			60,75	60,75	15.06	34	18.25	665	835							
	364TS/365TS	75,100	60,75				32		730	820							
	404TS/405TS	125,150	100			18	36	20.13	950	1150							
	404T/405T			100,125	100		39		930	1160							
	444TS/445TS	200-300	125,150			19.56	41	22.38	1250	1615							
	444T/445T			150-300	125-200		45		1370	1650							
	447TS	350	200				47		1800	2550							
449TS	400-450	250-400			21.69	51	23.75	1850	2550								
447T			350	250		48		1800	2260								
20BF	324T/326T			40,50	40,50	14.13	30	16.50	440	580	29.06	48	15.75	13.66	43.75	244	1"
	324TS/325TS	50,60	40,50				29		480	520							
	364T/365T			60,75	60,75	15.06	34	18.25	665	835							
	364TS/365TS	75,100	60,75				32		730	820							
	404TS/405TS	125,150	100			18	36	20.13	950	1150							
	404T/405T			100,125	100		39		930	1160							
	444TS/445TS	200-300	125,150			19.56	41	22.38	1250	1615							
	444T/445T			150-300	125-200		45		1370	1650							
	447TS	350	200				47		1800	2550							
	449TS	400-450	250-400			21.69	51	23.75	1850	2550							
447T			350	250		48		1800	2260								

NOTE: 1. Dimensions in inches, weight in pounds.
2. Not to be used for construction purposes.

NOTA: 1. Dimensiones en pulgadas, peso en libras.
2. No utilizar con fines de construcción.

* Premium efficiency where required by Department of Energy regulations. * Eficacia superior donde se requiera por el Ministerio de regulaciones de la Energía.

3756 M & L-GROUP SAE DRIVE DIMENSIONS AND WEIGHTS DIMENSIONES Y PESOS DEL MANDO SAE GRUPO L Y 3756 M

PACKED BOX CAJA PRENSAESTOPAS

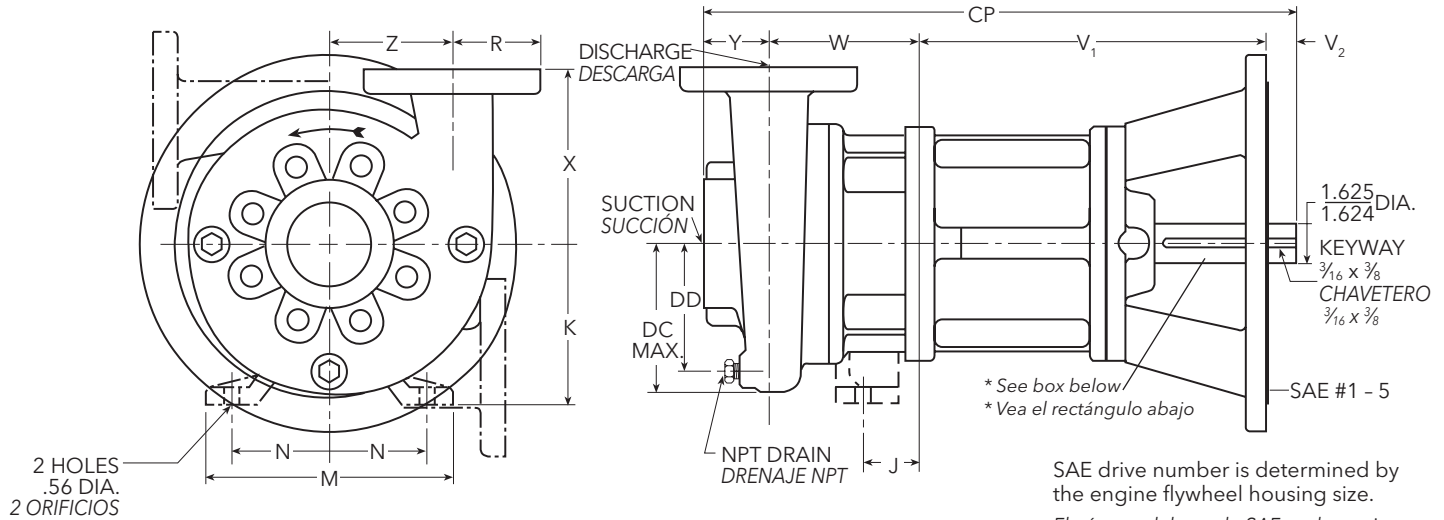

SAE drive number is determined by the engine flywheel housing size.
El número del mando SAE se determina por el tamaño de la caja del volante del motor.

Dimensions and Weights Pesos y dimensiones

Pump Bomba	Suction Succión	Discharge Descarga	CP	DC (Max.)	DD	J	K	M	N	R	NPT Drain Drenaje NPT	W	X	Y	Z	Weight (lbs.) Pesos (libras)	
1 1/2 x 2 -10	2*	1 1/2*	25 7/16	6 3/4	5 7/8	-	-	-	-	1 1/4	1/4	7 7/8	6	3	5 1/2	235	
2 1/2 x 3 -8	3*	2 1/2*	25 15/16	6 1/4	5 1/4	-	-	-	-	1 13/16		8			3 3/8	5	220
2 1/2 x 3 -9	3	2 1/2	25 3/16	7 1/8	6	-	-	-	-	3 1/2	3/8	7 7/8	7 1/2	2 3/4	5 1/2	230	
2 1/2 x 3 -10			25 5/16	8 1/8	7 3/8	-	-	-	-						9	3	7 1/2
2 1/2 x 3 -13	4	3	22 3/4	6 1/4	5 7/8	-	-	-	-	3 3/4	1/4	8 3/16	7	3	5 7/8	225	
3 x 4 -8			25 5/16	7 3/8	6 1/2	-	-	-	-			8			7 1/2	5 1/2	240
3 x 4 -10			25 7/16	9 1/2	8 7/8	-	-	-	-			7 7/8			9	7 1/2	300
3 x 4 -13	5	4	25 13/16	6 7/8	5 3/4	-	-	-	-	4 1/2	3/8	8 3/8	8	3	5	240	
4 x 5 -8			27 1/16	8 5/8	7 1/2	-	-	-	-			8 3/8			8 1/2	3 3/8	7
4 x 6 -10	6	4	25 1 1/16	9 3/4	8 7/8	-	-	-	-	4 1/2	3/8	8 7/8	9	3	7 1/2	315	
4 x 6 -13			27 3/16	12 3/4	11	1 15/16	9 3/4	16	7			8 7/8			12	4	10 1/2
n 4 X 6 -16	8	6	25 1 5/16	12 3/4	10 1/2	2 3/8	7 1/2	13	5 1/2	5 1/2	3/8	8 7/8	11	3 3/8	8 3/4	400	
n 6 X 8 -13			27 3/16	14 3/4	13	2 3/8	7 1/2	13	5 1/2	6 3/4		8 7/8			12 3/4	4	10
n 8 x 10 -13	10	8	27 3/16	14 3/4	13	2 3/8	7 1/2	13	5 1/2	6 3/4	3/8	8 7/8	12 3/4	4	10	585	

*Denotes NPT connection. All other connections are for use with ANSI class 150 mating flanges. Dimensions in inches, weights in lbs. Do not use for construction purposes.

* Indica conexión NPT Las demás conexiones deben usarse con bridas de contacto ANSI clase 150.

Dimensiones en pulgadas, peso en libras. No utilizar para fines de construcción.

n Indicates "L" Group pump., n Indica una bomba Grupo "L".

NOTE:

- All pumps shipped in horizontal discharge position. For other orientations, remove casing bolts, rotate to desired position, and tighten 3/8" - 16 casing bolts to 37 ft./lbs. torque., 1/2" - 13 casing bolts to 90 ft./lbs. torque.
- Dimensions in inches, weight in pounds.
- Not to be used for construction purposes.

NOTA:

- Todas las bombas se embarcan con la descarga en posición horizontal. Para otras orientaciones, retire los pernos de la carcasa, haga rotar la descarga hasta la posición deseada y ajuste los 16 pernos de 3/8 de pulgada a una torsión de 37 pies/libra, y los 13 pernos de 1/2 pulgada a 90 pies/libra.
- Dimensiones en pulgadas, peso en libras.
- No utilizar con fines de construcción.



SAE #	V ₁	V ₂
1, 3, 5	13 1/4	11 1/2
2, 4	13	13 1/4

SAE drives have a splined shaft option - see price book for ordering information. Spline size is 10T, 1 1/2" diameter.

Los mecanismos impulsores del SAE hacen que una opción ranurada del eje - considere el libro del precio para la información el ordenar. La talla de la tira es 10T, diámetro de 1 1/2".

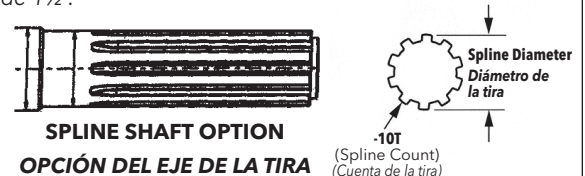

3756 M & L-GROUP SAE DRIVE DIMENSIONS AND WEIGHTS DIMENSIONES Y PESOS DEL MANDO SAE GRUPO L Y 3756 M

MECHANICAL SEAL SELLO MECÁNICO

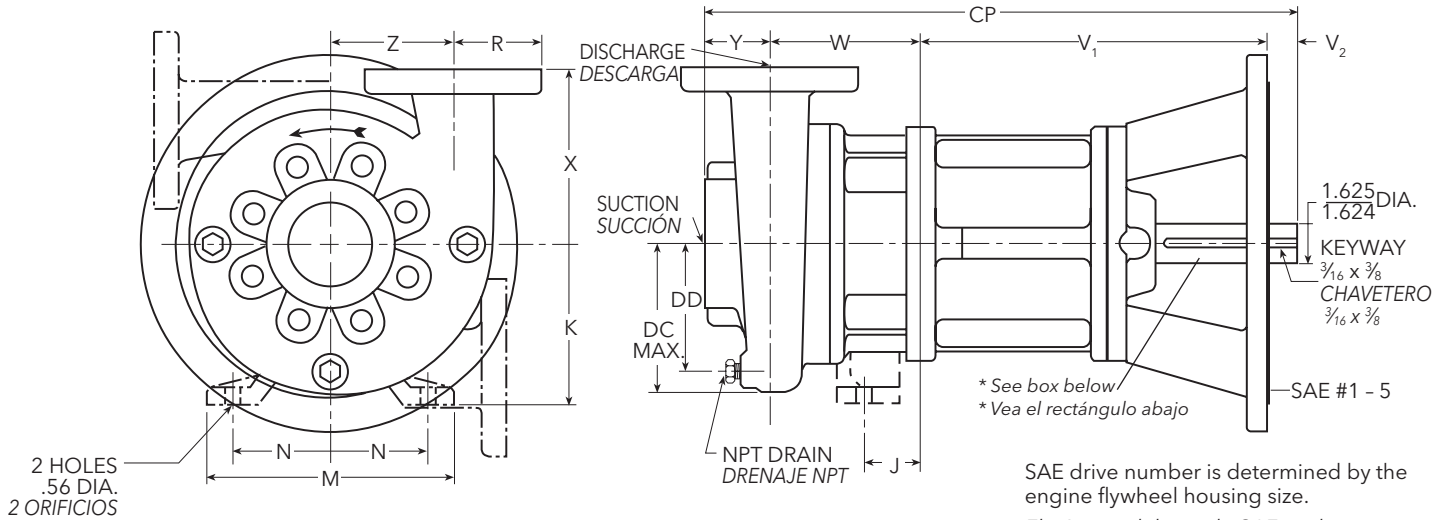

Dimensions and Weights Pesos y dimensiones

Pump Bomba	Suction Succión	Discharge Descarga	CP	DC (Max.)	DD	J	K	M	N	R	NPT Drain Drenaje NPT	W	X	Y	Z	Weight (lbs.) Pesos (libras)			
1 1/2 x 2 - 10	2*	1 1/2*	22 7/16	6 3/4	5 7/8	-	-	-	-	1 1/4	1/4	5	6	3	5 1/2	235			
2 1/2 x 3 - 8	3*	2 1/2*	23 3/16	6 1/4	5 1/4	-	-	-	-	1 13/16		5 1/8				3 3/8	5	220	
2 1/2 x 3 - 9	3	2 1/2	22 5/16	7 1/8	6	-	-	-	-	3 1/2	3/8	5	7 1/2	2 3/4	5 1/2	230			
2 1/2 x 3 - 13			22 7/16	8 7/8	7 5/8	-	-	-	-	9						3	7 1/2	285	
3 x 4 - 8	4	3	19 7/8	6 1/4	5 3/8	-	-	-	-	3 3/4	1/4	5 5/8	7	3	5 5/8	225			
3 x 4 - 10			22 11/16	7 3/8	6 1/2	-	-	-	-			5 1/8			7 1/2	5 1/2	240		
3 x 4 - 13			22 9/16	9 1/2	8 1/8	-	-	-	-			5			9	7 1/2	300		
4 x 5 - 8	5	4	22 15/16	6 7/8	5 3/4	-	-	-	-	4 1/2	3/8	5 1/2	8	3 3/8	7	240			
4 x 6 - 10			24 5/16	8 5/8	7 1/2	-	-	-	5 1/2			8 1/2				3 1/8	280		
4 x 6 - 13			22 13/16	9 3/4	8 1/8	-	-	-	5 1/4			9				3	7 1/2	315	
n 4 x 6 - 16	6	4	27 3/16	12 3/4	11	1 7/8	9 3/4	16	7	5 1/2	3/8	8 7/8	12	4	10 1/2	500			
n 6 x 8 - 13			25 15/16	12 3/4	10 1/2	2 3/8	7 1/2	13	5 1/2			8 7/8				11	3 3/8	8 3/4	400
n 8 x 10 - 13			27 3/16	14 3/4	13	2 3/8	7 1/2	13	5 1/2			8 7/8				12 3/4	4	10	585

*Denotes NPT connection. All other connections are for use with ANSI class 150 mating flanges. Dimensions in inches, weights in lbs. Do not use for construction purposes.

* Indica conexión NPT. Las demás conexiones deben usarse con bridas de contacto ANSI clase 150. Dimensiones en pulgadas, peso en libras. No utilizar para fines de construcción.
n Indicates "L" Group pump., n Indica una bomba Grupo "L".

NOTE:

- All pumps shipped in horizontal discharge position. For other orientations, remove casing bolts, rotate to desired position, and tighten 3/8 - 16 casing bolts to 37 ft./lbs. torque., 1/2 - 13 casing bolts to 90 ft./lbs. torque.
- Dimensions in inches, weight in pounds.
- Not to be used for construction purposes.

NOTA:

- Todas las bombas se embarcan con la descarga en posición horizontal. Para otras orientaciones, retire los pernos de la carcasa, haga rotar la descarga hasta la posición deseada y ajuste los 16 pernos de 3/8 de pulgada a una torsión de 37 pies/libra, y los 13 pernos de 1/2 pulgada a 90 pies/libra.
- Dimensiones en pulgadas, peso en libras.
- No utilizar con fines de construcción.



SAE #	V ₁	V ₂
1, 3, 5	13 1/4	1 1/2
2, 4	13	1 3/4

SAE drives have a splined shaft option - see price book for ordering information. Spline size is 10T, 1 1/2" diameter.

Los mecanismos impulsores del SAE hacen que una opción ranurada del eje - considere el libro del precio para la información el ordenar. La talla de la tira es 10T, diámetro de 1 1/2".



SPLINE SHAFT OPTION
OPCIÓN DEL EJE DE LA TIRA

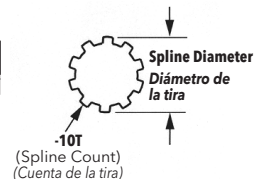

SPECIFICATIONS

Capacities to:

1600 GPM (363 m³/hr) at 3500 RPM
4500 GPM (1020 m³/hr) at 1750 RPM

Heads to:

490 feet TDH (150 m) at 3500 RPM
300 feet TDH (90 m) at 1750 RPM

Working pressure to:

200 PSIG (14 bars)

Suction pressure to:

100 PSIG (7 bars)

Maximum temperature to:

212°F (100°C) with standard seal or 250°F (121°C) with optional seal.

Motor:

NEMA standard JM frame for 3656 or T-frame for 3756 mechanical seal, JP or T-frame for packed box. Open drip proof*, totally enclosed fan cooled* and explosion proof* enclosures available. Single phase (115/230 V), 2-5 HP and three phase (230/460 V) 2 - 150 HP are available at 1750 or 3500 RPM.

Direction of Rotation:

Clockwise viewed from motor end.

* Premium efficiency where required by Department of Energy regulations.

ESPECIFICACIONES

Capacidad hasta:

1600 GPM (363 m³/hr) a 3500 RPM
4500 GPM (1020 m³/hr) a 1750 RPM

Cargas hasta:

490 pies (150 m) carga dinámica total a 3500 RPM
300 pies (90 m) carga dinámica total a 1750 RPM

Presión de operación hasta:

200 PSIG (14 bars)

Presión de succión hasta:

100 PSIG (7 bars)

Temperatura máxima:

212 °F (100 °C) con sello estándar o 250 °F (121 °C) con sello optativo.

Motor:

NEMA JM estándar en el modelo 3656 y bastidor NEMA T estándar en el modelo 3756 con sello mecánico, bastidor JP o T para caja prensaestopas. Las cubiertas disponibles son: abierta a prueba de filtración*, totalmente encerrada con enfriamiento por ventilador* y a prueba de explosiones*. Motores monofásicos (115/230 V), 2-5 HP y trifásicos (230/460 V) 2 - 150 HP disponibles a 1750 ó 3500 RPM.

Dirección de rotación:

Dextrorsa (sentido de las agujas del reloj) cuando se mira desde el extremo del motor.

* Eficacia superior donde se requiera por el Ministerio de regulaciones de la Energía.

TYPICAL APPLICATIONS

- Booster service
- Spraying systems
- Irrigation
- Water circulation
- Liquid transfer
- General purpose pumping

APLICACIONES TÍPICAS

- Servicio de refuerzo
- Sistemas de rociado
- Sistemas de riego
- Circulación de agua
- Transferencia de líquidos
- Aplicaciones de bombeo en general

13AI/BF MOTOR SIZING

Impeller	3500 RPM	Motor Selection 1.0
	Max HP	
A	23.0	25
B	21.8	20
C	18.9	20
D	16.5	15
E	14.0	15
F	12.0	15
G	10.1	15
H	8.1	10

NOTES

Xylem |'zīləm|

- 1) The tissue in plants that brings water upward from the roots;
- 2) a leading global water technology company.

We're a global team unified in a common purpose: creating advanced technology solutions to the world's water challenges. Developing new technologies that will improve the way water is used, conserved, and re-used in the future is central to our work. Our products and services move, treat, analyze, monitor and return water to the environment, in public utility, industrial, residential and commercial building services settings. Xylem also provides a leading portfolio of smart metering, network technologies and advanced analytics solutions for water, electric and gas utilities. In more than 150 countries, we have strong, long-standing relationships with customers who know us for our powerful combination of leading product brands and applications expertise with a strong focus on developing comprehensive, sustainable solutions.

For more information on how Xylem can help you, go to www.xylem.com



Xylem Inc.
2881 East Bayard Street Ext., Suite A
Seneca Falls, NY 13148
Phone (Teléfono): (866) 673-0428
Fax: (888) 322-5877
www.xylem.com/goulds

Goulds is a registered trademark of Goulds Pumps, Inc. and is used under license. All other trademarks or registered trademarks are property of their respective owners. Goulds es una marca registrada de Goulds Pumps, Inc. y se utiliza bajo licencia. Todas las demás marcas comerciales o registradas pertenecen a sus respectivos propietarios.

© 2022 Xylem Inc. B3656M/L R7 November (Noviembre) 2022